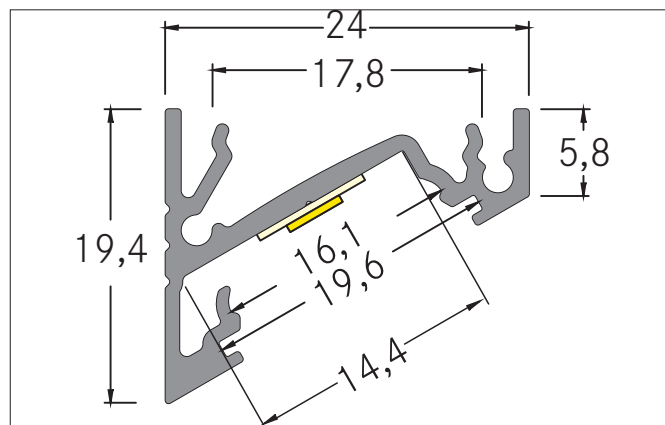

QUALITYFLEX ONE Surface-mounted corner profile

Article no. 53385262

Light.
For Generations.**Tender**

Surface-mounted corner profile, alu. For optimal attachment of the profile this holders are suitable 53040000. With the use of profile covers 53489071 53489072 53489073 53489001 53489002 53489003 the additional mechanical protection and optimal light distribution can be achieved. The associated end cap set is under 53037260 available. for Mounting method: Mounting profile. Material: Aluminium, dimensions profile: length: 2.000 mm x width: 24 mm x height: 19,4 mm .

Product Benefits

- Simple surface-mounted corner profile.
- Profile and matching covers available in 1 meter, 2 meter and 3 meter lengths.
- Optimal heat dissipation for long-lasting lighting.

Article data	
Article no.	53385262
GTIN	4251433944751
Series name	QUALITYFLEX ONE
Short description	Surface-mounted corner profile
Material	Aluminium
Colour	Alu
Length	2,000 mm
Width	24 mm
Hight	19.4 mm
Weight	0.440 kg

QUALITYFLEX ONE Surface-mounted corner profile

Article no. 53385262

Light.
For Generations.

Packing data	
Gross weight	0.448 kg
Length of packaging	24 mm
Packaging width	20 mm
Packaging height	2,001 mm
Note	Please note that the materials aluminium and PMMA or PC can expand differently with changes in temperature! At a temperature change of 10°C, the coefficient of expansion is approx. aluminium is approx. 0.7mm per metre, for plastic approx. 1.5mm per metre. This is not a defect in the product, this is a normal physical process.
Disposal at end of life	This product must not be disposed of with household waste. You are obliged, to dispose of such electrical waste separately. By disposing of electrical waste and other old or defective electronics separately, you support recycling or other forms of re-use. In that way you help to take care and to avoid that harmful substances get into the environment.