

Cell Type CR17450E-R Specifications

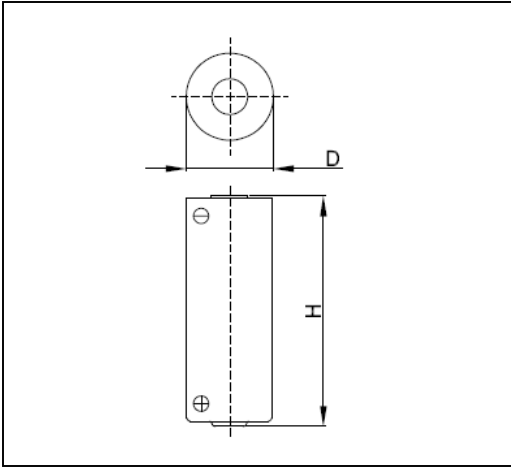

Nominal Voltage (V)		3
Nominal Capacity (mAh) ^{*1}		2400
Standard Discharge Current (mA)		5
Max. Pulse Discharge Current (mA) ^{*2}		2500
Operating Temperature Range (°C) ^{*3}		-40 ~ +85
Dimensions (mm)	Diameter (D)	17.0
	Height (H)	45.0
Approx. Weight (g)		23

*1 Nominal capacity is determined at an end voltage of 2.0V when the battery is allowed to discharge at a standard current level at +23°C.

*2 Current value for obtaining 1.0V cell voltage when pulse is applied for 15 seconds at 50% discharge depth (50% of the nominal capacity) at 23°C.

*3 Consult with FDK when using batteries at temperatures exceeding -20°C to +60°C range.

Note) Battery Handling Precautions

English) http://www.fdk.com/battery/lithium_e/handling_precaution.html

Japanese) http://www.fdk.co.jp/battery/lithium/handling_precaution.html

Typical Characteristics

Temperature Discharge Characteristics

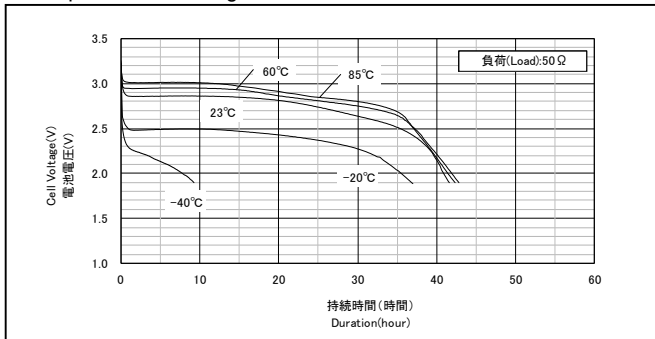

Temperature Discharge Characteristics

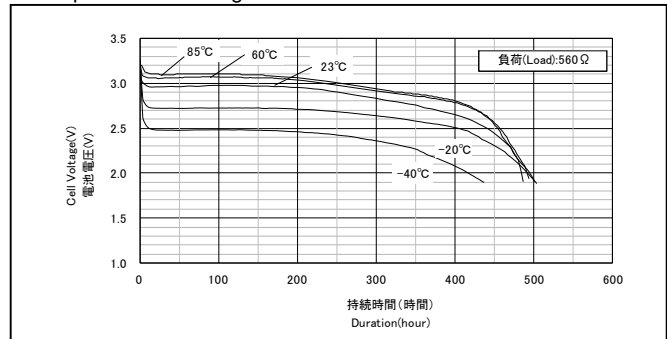

Temperature Discharge Characteristics

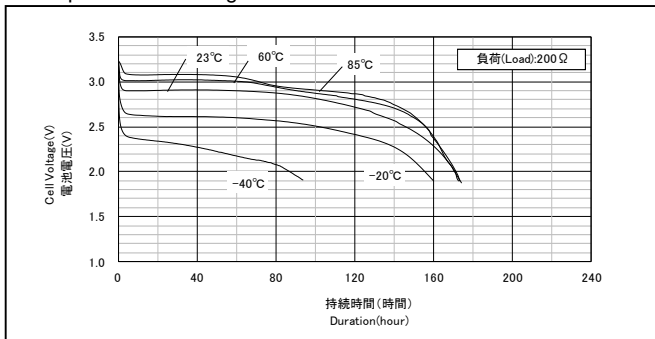

Discharge Characteristics after Storage

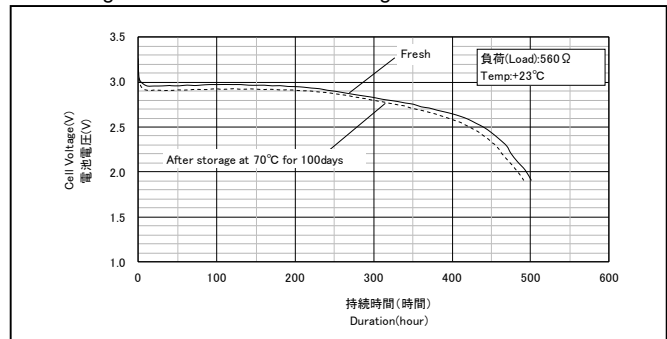

Discharge Load vs. Capacity

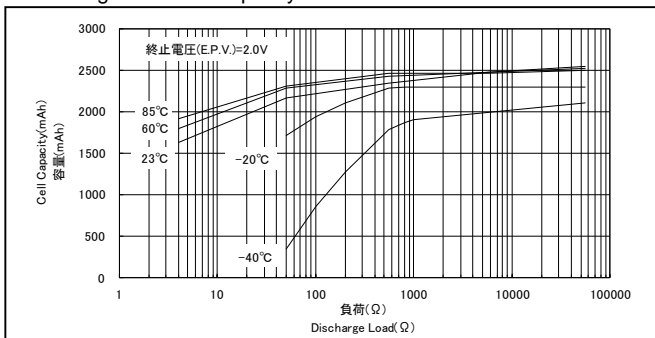

Discharge Load vs. Operating Voltage

