

AMJ-K Module Cat.6_A for RJ45/11/12 plugs

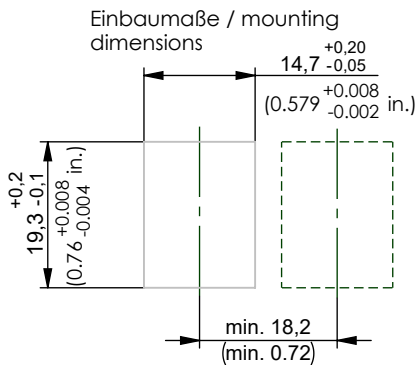

Einbaumaße / mounting dimensions
Materialdicke 1,5+0,05 mm
wall thickness 1,5+0,05 mm (0.059+0.002 in.)

Anschlussbelegung / PIN assignment T568A
nach / according to TIA-568.2

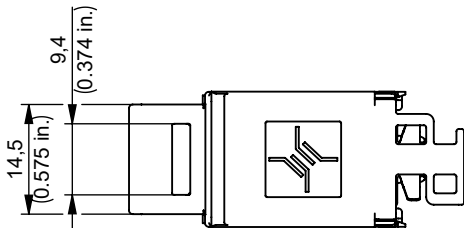
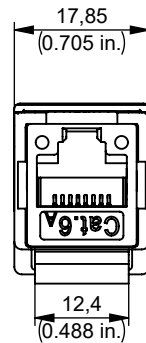
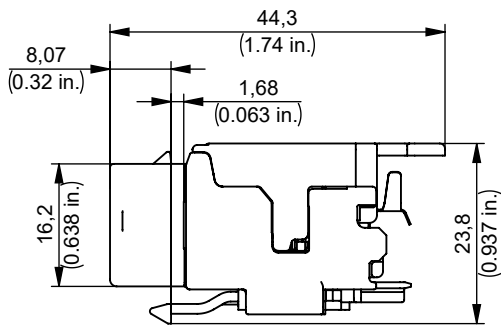
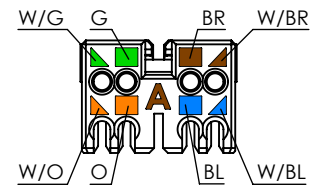

Anschlussbelegung / PIN assignment T568B
nach / according to TIA-568.2

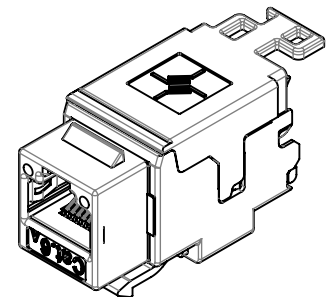
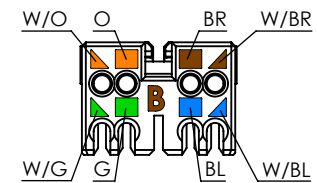

TG-Artikelnummer TG part number	Bezeichnung Description	Barcode EAN 13	VPE PU				
100023225 J00029K0036	AMJ Modul / AMJ Module K Cat.6 _A T568A	4018359318413	2				
100023173 J00029A0077	AMJ Modul / AMJ Module K Cat.6 _A T568B	4018359330637	2				
100023231 J00029L0036	AMJ Modul / AMJ Module K Cat.6 _A T568A	4018359318451	24				
100023215 J00029B0077	AMJ Modul / AMJ Module K Cat.6 _A T568B	4018359330644	24				
TG-Artikelnummer TG part number	Verpackung Packing	VPE PU	Karton Carton	UPE OPU	Karton Carton	UPE OPU	Karton Outer carton
100023225 J00029K0036	2 pcs. in carton, 4 cable ties	2 pcs in carton	49x49x49,5 [mm]	6 cartons in carton, one mounting information	154x104x56 [mm]	50 cartons in outer carton	530x380x260 [mm]
100023173 J00029A0077	2 pcs. in carton, 4 cable ties	2 pcs in carton	49x49x49,5 [mm]	6 cartons in carton, one mounting information	154x104x56 [mm]	50 cartons in outer carton	530x380x260 [mm]
100023231 J00029L0036	24 pcs. in blister pack, one mounting information	24 pcs in blister pack	-	-	-	21 blister packs in outer carton	520x310x220 [mm]
100023215 J00029B0077	24 pcs. in blister pack, one mounting information	24 pcs in blister pack	-	-	-	21 blister packs in outer carton	520x310x220 [mm]

Montageanleitung siehe: www.telegaertner.com
Mounting instructions see: www.telegaertner.com

AMJ-K Module Cat.6A for RJ45/11/12 plugs

Optional

Für IP20 Anwendung:

Staubschutzklappen sind in unterschiedlichen Farben erhältlich und müssen separat bestellt werden.

For IP20 application:

Retrofit dust protection flaps are available in different colours and need to be ordered separately.

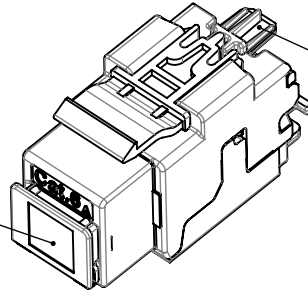

Flachstecker 2,8 mm DIN46342-1 für Funktionserdung IEC60364-5-54
blade terminal 2,8 mm DIN46342-1 for functional earthing acc. to IEC60364-5-54

TG-Artikelnummer TG part number	Bezeichnung Description	Barcode EAN 13	Farbe Colour	Ähnlich similar RAL	VPE PU
100027359	Retrofit dust protection flap for Modules	4018359325701	schwarz / black	RAL 9005	100 pcs. in PE bag
100027360	Retrofit dust protection flap for Modules	4018359325718	orange / orange	RAL 2009	100 pcs. in PE bag
100027361	Retrofit dust protection flap for Modules	4018359325725	grün / green	RAL 6017	100 pcs. in PE bag
100027362	Retrofit dust protection flap for Modules	4018359325732	blau / blue	RAL 5015	100 pcs. in PE bag
100027363	Retrofit dust protection flap for Modules	4018359325749	gelb / yellow	RAL 1023	100 pcs. in PE bag

Technische Daten / Technical Data		
Steckverbinder-Norm	IEC 60603-7-51	Connector Standard
Mechanische Eigenschaften		Mechanical Characteristics
Lebensdauer (Steckzyklen)	≥ 750	Life (mating cycles)
Werkstoffe		Materials
Gehäuse	Zinkdruckguß / zinc diecast	Housing
Schirmblech	Neusilber / German silver	Shield
Rasthaken	PC UL94 V0 schwarz / black	Stop hook
Adernvorsortierung	PBT UL94 V0 natur / nature	Wire presorting
Isolierteile	PBT natur / nature	Insulators
Leiterplatte	FR4 UL94 V0	PCB
Kontaktfeder	Federstahl / spring steel 0,8 µm (30 µin.) Au; 1,2 µm (50 µin.) Ni	Contact spring
Schneidklemmkontakt	CuNi2Si, min. 3...6 µm (120-240 µin.) Sn	IDC
Biegeschutz	PC glasklar / clear	Bending protection
Kabelbinder	PA UL94 V2	Cable tie
Richtlinie 2011/65/EU (RoHS)	RoHS-konform / RoHS-compliant	Directive 2011/65/EU (RoHS)
Adernanschluss		Wire Connection
Cu-Leiterdurchmesser	Massiv / solid 0,41 - 0,64 mm AWG26 - AWG22/1 Litze / stranded 0,46 - 0,76 mm AWG27 - AWG22/7	Cu-conductor diameter
Aderndurchmesser	0,9 - 1,6 mm (0.035-0.063 in.)	Core diameter
Wiederanschließbarkeit Schneidklemmkontakte	≤ 4 Zyklen / cycles für / for AWG 22/1 ≤ 4 Zyklen / cycles für / for AWG 22/7 ≤ 10 Zyklen / cycles für / for AWG 23/1 - AWG 26/1 ≤ 10 Zyklen / cycles für / for AWG 24/7 - AWG 27/7	Reusable IDC
Kabeldurchmesser	max. 9,0 mm (0.35 in.)	Cable diameter
Umweltanforderungen		Environmental Requirements
Schutz vor Eindringen		Protection against Ingress
Eindringen von Teilchen	IP2X	Particulate ingress
Wasser / Untertauchen	IPX0	Water / Immersion
Klimatisch und chemisch		Climatical and Chemical
Umgebungstemperatur	-40 °C bis / to +70 °C	Ambient temperature

Technische Daten / Technical Data		
Elektrische Eigenschaften		Electrical Characteristics
Kontaktwiderstand	≤ 20 mΩ	Contact resistance
Isolationswiderstand	≥ 500 MΩ	Insulation resistance
Spannungsfestigkeit		Voltage Proof
Kontakt-Kontakt	≥ 1000 V, DC	Contact-Contact
Kontakt-Schirm	≥ 1500 V, DC	Contact-Shield
Strombelastbarkeit bei 50 °C	1 A	Current carrying capacity at 50 °C
PoE gemäß IEEE 802.3af	Geeignet für Power over Ethernet Adequate for Power over Ethernet	PoE according to IEEE 802.3af
PoE+ gemäß IEEE 802.3at	Geeignet für Power over Ethernet+ Adequate for Power over Ethernet+	PoE+ according to IEEE 802.3at
4PPoE gemäß IEEE 802.3bt	Geeignet für 4 Pair Power over Ethernet Adequate for 4 Pair Power over Ethernet	4PPoE according to IEEE 802.3bt
Transfer-Impedanz		Transfer Impedance
Bei 1 MHz	≤ 100 mΩ	At 1 MHz
Bei 10 MHz	≤ 200 mΩ	At 10 MHz
Bei 80 MHz	≤ 1600 mΩ	At 80 MHz
Übertragungstechnische Eigenschaften *		Transmission Performance *
10 Gigabit Ethernet gemäß IEEE 802.3	Geeignet für 10 Gigabit Ethernet Adequate for 10 Gigabit Ethernet	10 Gigabit Ethernet acc. to IEEE 802.3
Kategorie 6 _A (Komponente)	ISO/IEC 11801; DIN EN 50173-1	Category 6 _A (Component)
Klasse E _A (Permanent Link)	ISO/IEC 11801; DIN EN 50173-1	Class E _A (Permanent Link)
Klasse E _A (Channel)	ISO/IEC 11801; DIN EN 50173-1	Class E _A (Channel)
Kategorie 6A	ANSI/TIA-568.2	Category 6A
Normen		Standards
IP-Schutzarten	IEC 60529	Degrees of protection provided by enclosures (IP code)
Anwendungsneutrale Kommunikationsanlagen	ANSI/TIA-568.2; ISO/IEC 11801; DIN EN 50173-1	Generic cabling systems

* Für alle aufgeführten Standards gelten die aktuellen und publizierten Ausgabestände zum 14.08.2025.

* The editions of the aforementioned standards by the time of 14.08.2025 are valid.

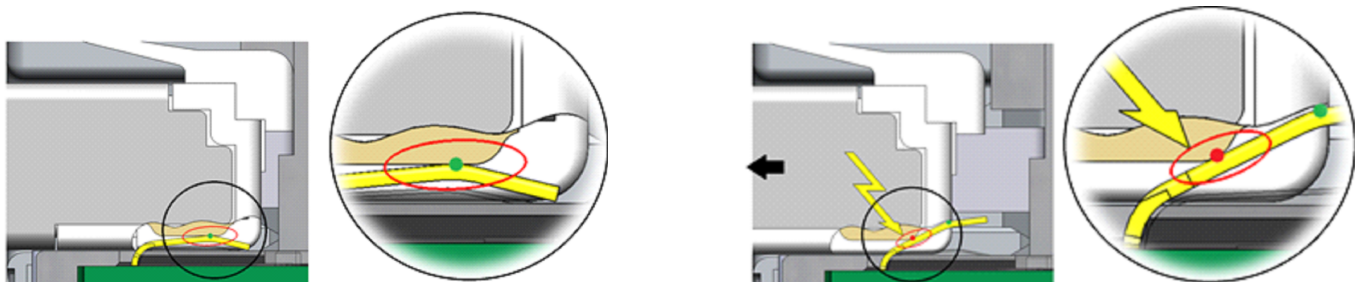

Das Kontakt-Design im beschriebenen Steckverbindersystem ist so optimiert, dass beim Ziehen unter Last der Kontaktbereich im gesteckten Zustand nicht beeinträchtigt wird.

Es muss darauf hingewiesen werden, dass gemäß Standards ein Ziehen unter Last für Steckverbinder nicht vorgesehen ist, anders als bei Steckvorrichtungen.

Optimized contact design of shown connecting hardware, which avoid damages by reconnecting under load.

Please notice that reconnecting under load is not allowed for connection hardware in accordance to terms of standardization, different to power connectors.