

50W Intelligent LED Driver (Constant Voltage)

09.50CVT.04084



Important: Read All Instructions Prior to Installation

Function introduction

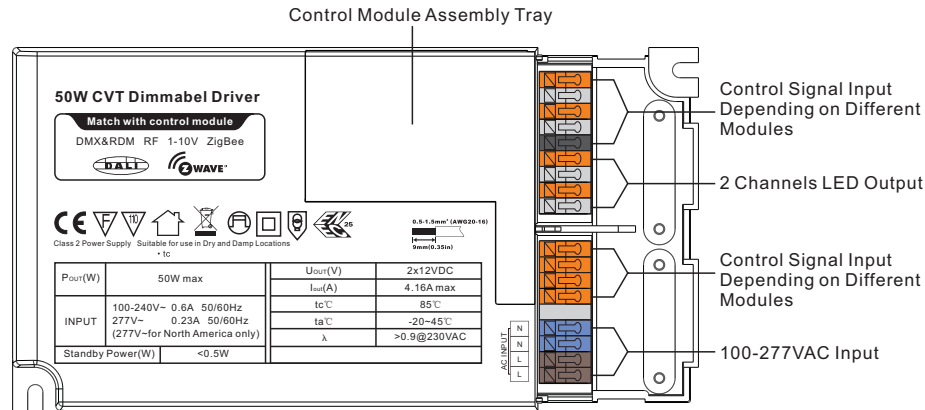

Product Data

Output	LED Channel	2
	DC Voltage	12V DC
	Max. Current	Max. 4.16A/ch, ch1+ch2=4.16A
	Voltage Tolerance	±1%
	Rated Power	Max. 50W
Input	Voltage Range	100-277V AC
	Frequency Range	50/60Hz
	Power Factor (Typ.)	> 0.95 @ 230VAC
	Total Harmonic Distortion	THD ≤ 15% (@ full load / 230VAC)
	Efficiency (Typ.)	84% @ 230VAC full load
	AC Current (Typ.)	0.6A @ 230VAC, 0.23A @ 277VAC
	Inrush Current (Typ.)	COLD START 1.2A at 230VAC
	Leakage Current	< 0.5mA/230VAC
	Standby Power Consumption	< 0.5W

Control	Dimming Interface	Plug-in type DALI (DT6/DT8), DMX/RDM, RF, 1-10V, ZigBee, Z-Wave
	Dimming Range	0%-100%
	Dimming Method	Pulse Width Modulation
Protection	Short Circuit	Yes, recovers automatically after fault condition is removed
	Over Current	Yes, recovers automatically after fault condition is removed
	Over Temperature	Yes, recovers automatically after fault condition is removed
Environment	Working Temp.	-20°C ~ +45°C
	Max. Case Temp.	85°C
	Working Humidity	10% ~ 95% RH non-condensing
	Storage Temp. & Humidity	-40°C ~ +80°C, 10% ~ 95% RH
Safety & EMC	Safety Standards	EN61347-1, EN61347-2-13
	Withstand Voltage	I/P-O/P: 3.75KVAC
	Isolation Resistance	I/P-O/P: 100M Ohms / 500VDC / 25°C / 70% RH
	EMC Emission	En55015, EN61000-3-2, EN61000-3-3
	EMC Immunity	En61547, EN61000-4-2,3,4,5,6,8,11, surge immunity Line-Line 1KV
Others	MTBF	193.6K hrs min. @ 230VAC full load and 25°C ambient temperature
	Dimension	158.7*84*38mm (L*W*H)

- 50W independent LED driver with full isolated design
- Supplied with terminal cover and cable retainer
- 100-277VAC wide input, 2 channels 12V constant voltage output
- Innovative plug-in control module, easy assembly and disassembly
- Work with multiple modules: DALI (DT6/DT8), DMX/RDM, RF, 1-10V, ZigBee, Z-Wave
- Standby power consumption <0.5W
- 1500Hz PWM frequency, smooth and deep dimming to 0.1%, flicker free, no noise
- Built-in active PFC function
- Class II protection against electric shock for direct or indirect contact
- Protections: short circuits, over temperature, over voltage
- To protect load against overheating when work with an external thermistor
- Suitable for use on normally flammable surfaces
- 5 years warranty (3% failure rate)

Safety & Warnings

- DO NOT assemble control module with power applied to the device.
- DO NOT install with power applied to the device.
- DO NOT expose the device to moisture.
- DO NOT change the control module within 1 minute after powering off the driver to avoid burning-out.

Assemble the Control Module

▼ Before assembly the control module, please power off

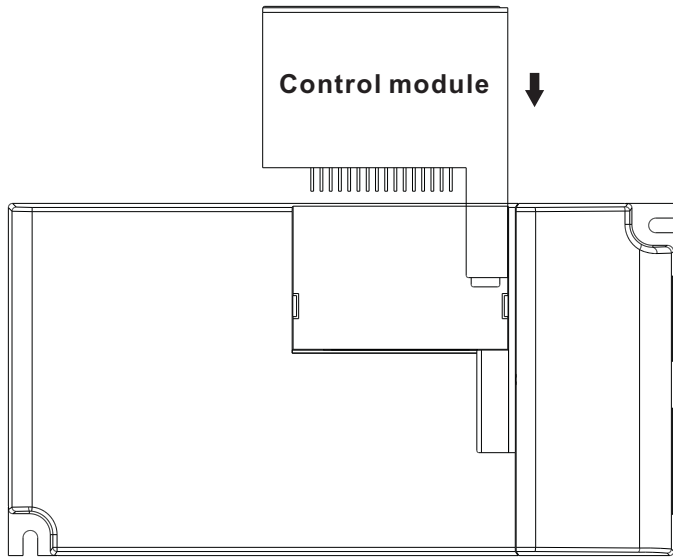

Match with control module

Compatible Control Modules: RF, DMX512, DMX512&RDM, DALI DT6, DALI DT8, 1-10V, ZigBee, Z-Wave

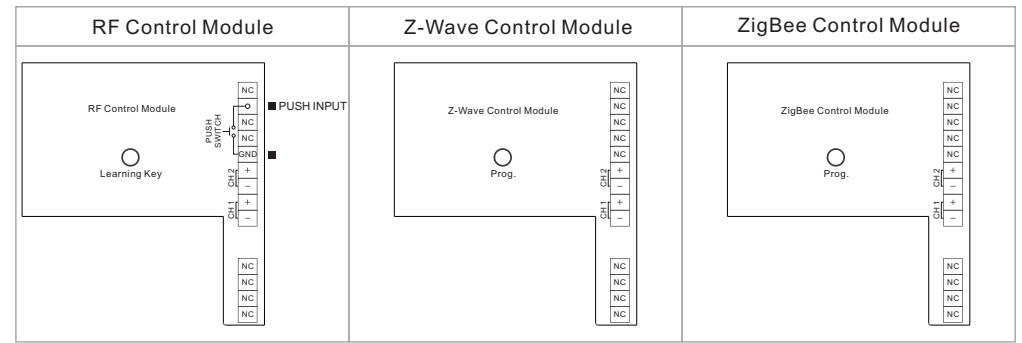

Wiring diagram

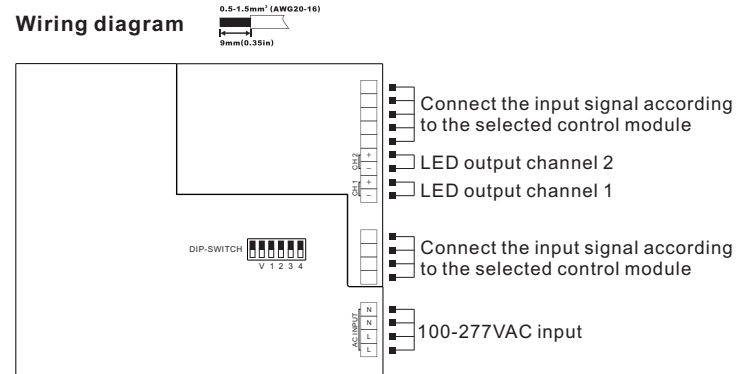

Note: for detailed wiring diagram, please refer to the user manual of corresponding control module.

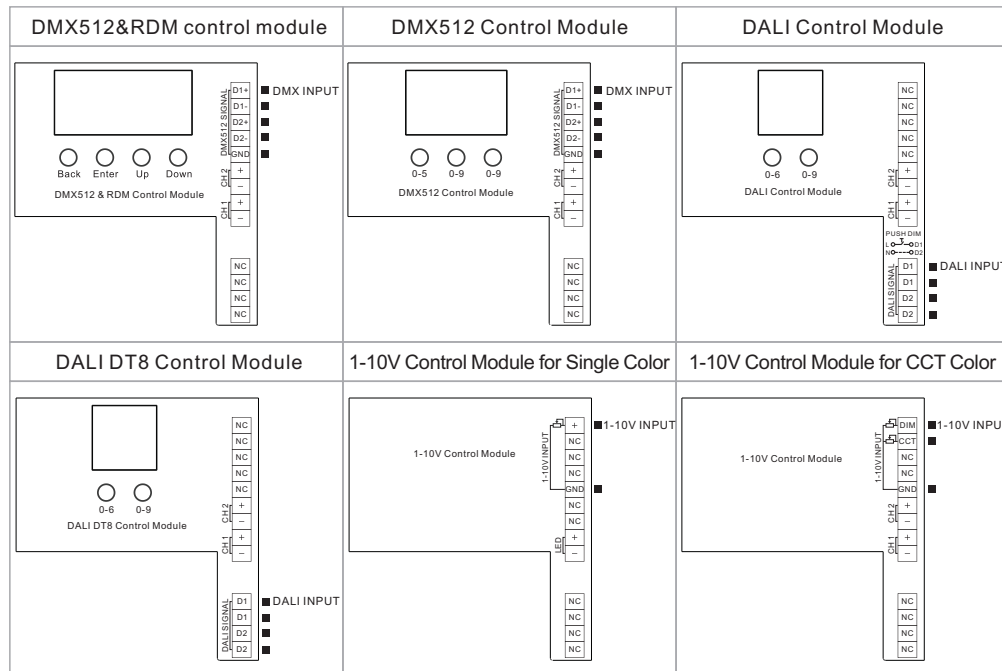

Product Dimension

