

Zubehör Anbausteckdosen - Befestigung 44x44 mm

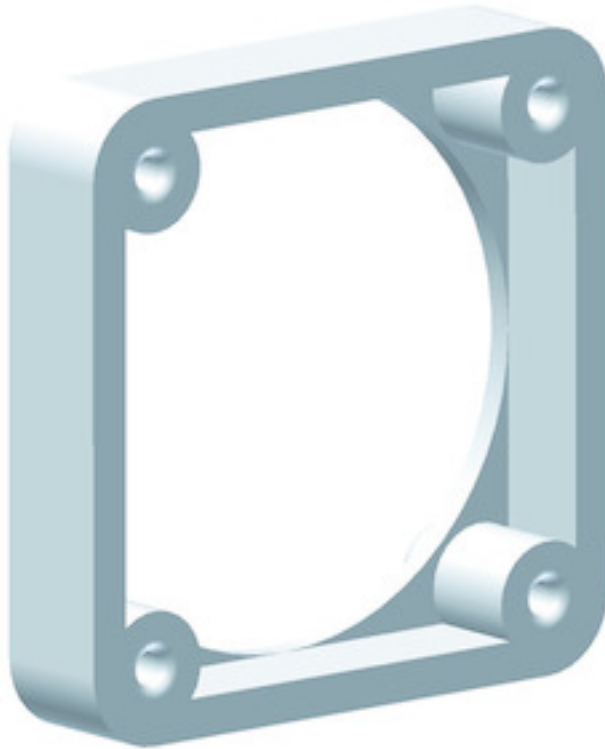

Artikelbeschreibung	
BALS-Art.-Nr	1847
EAN	4024941018470
Produktgruppe	Montagerahmen
Kennfarbe	grau
Gehäusematerial	Polyamid

Logistikdaten	
Einzelgewicht	0,015 kg / Stück
Verpackungsart	Tüte
Inhaltsmenge	1 ST

Logistikdaten	
EAN	4024941018470
Länge	410 mm
Breite	285 mm
Gewicht	0,016 kg
Verpackungsart	Karton
Inhaltsmenge	100 ST
EAN	4024941326957
Länge	275 mm
Breite	175 mm
Höhe	137 mm
Gewicht	1,625 kg
Volumen	5.737,5 ccm

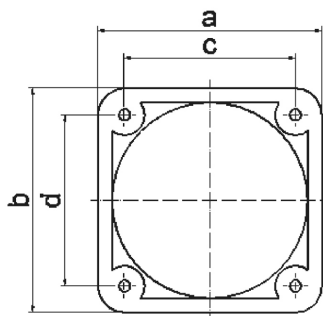

a	b	c	d	e	Bestell-Nr.
50	50	38	38	13	1843
54	54	44	44	10	1847
57	66	47	47	10	1848
60	60	50	50	10	1849
62	62	52	52	10	1850
62	70	52	60	10	1851

30 MB 182