

PA 10/20

PA X 10-10/ PA X 10-15

PA X 20-10/ PA X 20-15

Betriebs- und Montageanleitung

Maße

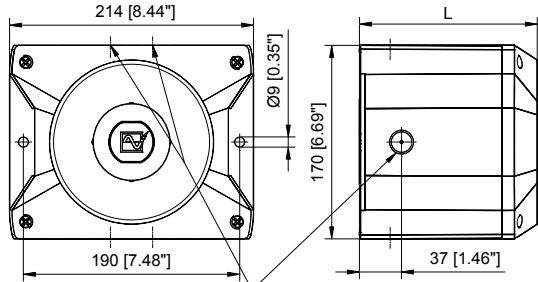

Kartoninhalt:
 1x Alarmgerät
 1x Membrannippel M20
 1x Betriebsanleitung
 1x Widerstand (nur -SSM)

	L
PA (X) 10..	156,2 mm [6,15"]
PA (X) 20..	181,2 mm [7,13"]

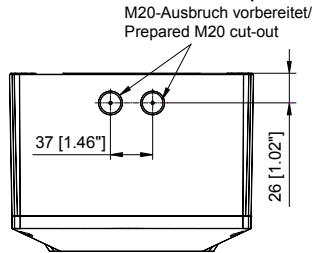
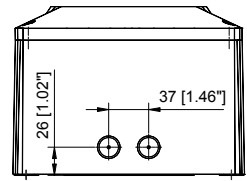

PA 10/ PA 20

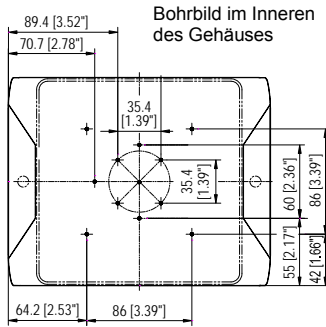

Bohrbild im Inneren des Gehäuses

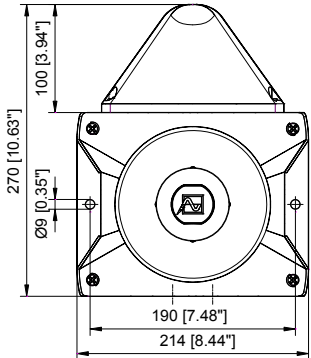
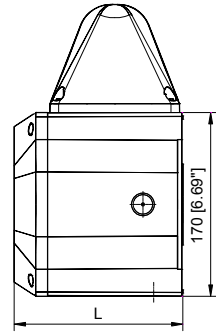

**PA X 10-10/ PA X 10-15
 PA X 20-10/ PA X 20-15**

Technische Daten

	PA 10	PA 20	PA X 10-10	PA X 10-15	PA X 20-10	PA X 20-15
Nennschallpegel	110dB (A) 1m	120dB (A) 1m	110dB (A) 1m		120dB (A) 1m	
Lautstärkeregelung	-10dB	-9dB	-10dB		-9dB	
Töne	80					
Blitzenergie	-		10J	15J	10J	15J
Blitzfolgefrequenz	1Hz					
Bemessungs-Spannung (Begrenzungen siehe Zulassungen)	24 V DC oder 12-48V DC 24V AC	110 – 240 V AC 50/60 Hz 24 V DC oder 12-48V DC 24V AC	12V DC 24V DC 48V DC 24V AC	12V DC 24V DC 48V DC 24V AC	12V DC 24V DC 48V DC 24V AC	12V DC 24V DC 48V DC 24V AC
Spannungsbereich	10 – 60 V 20 – 30V	95 – 265 V 10 – 60 V 20 – 30V	10,5 – 15 V 18V – 30V 40V – 60V 20 – 30V	10,5 – 15 V 18V – 30V 40V – 60V 20 – 30V	10,5 – 15 V 18V – 30V 40V – 60V 20 – 30V	10,5 – 15 V 18V – 30V 40V – 60V 20 – 30V
Stromaufnahme Schallgeber (max.) [mA]	24V: 360 12-48V: 485 850	140 24V: 800 12-48V: 880 1600	490 360 230 850	490 360 230 850	460 800 500 1600	460 800 500 1600
Stromaufnahme Blitzleuchte (max.) [mA]	-	-	1400 680 300 1400	1550 850 440 1400	1400 680 300 1400	1550 850 440 1400
Leistungsaufnahme	24V: 8,5 W 12-48V: 9W 17,5 VA	15,5 VA 24V: 24,5 W 12-48V: 27W 17,5 VA	22 W 22 W 32 W 54,5 VA	29 W 27,5 W 32,5 W 57 VA	27,5 W 38 W 50,5 W 80 VA	35 W 43,5 W 51 W 82,5 VA
Einschaltdauer	100%					
Anschlussklemmen	0,14 - 2,5mm ² feindrähtig / AWG24 - AWG 14 (stranded)					
Schutzart	IP66 (EN60529), Type 4 & 4x					
Schlagfestigkeit	IK08 (EN50102)					
Schutzklasse	II					
Betriebstemperatur	-40°C...+55°C					
Lagertemperatur	-40°C...+70°C					
Max. rel. Luftfeuchte	90%					
Kabeleinführung	7x M20 vorgeprägt		5x M20 vorgeprägt			
Dichtbereich der Durchführungsstülle	7 – 13 mm		Bei Verwendung von Kabeldurchmessern < 7 mm ist eine Kabelverschraubung mit ausreichender Schutzart vorzusehen			
Gehäusematerial	PC/ABS Blend					
Haubenmaterial	PC					
Einbaulage	beliebig					
Optionen	-SSM, (siehe Seite 5)					
Zubehör	Plombierstopfen (Art-Nr. 28300000002)					
Haubenfarben	klar, weiß, gelb, orange, rot, grün, blau					

Zulassungen

Zulassungen (gilt nur für gekennzeichnete Betriebsmittel)				
Bauproduktverordnung (305/2011/EU) 	PA10/ PA 20, 110-230V AC:	PA10/ PA 20, 24-48V DC:	PA10-SSM, PA 20-SSM:	
	VdS 0786-CPD- 21184	VdS 0786-CPD- 21223	0786-CPD- 21224	
	PA 10/ PA 20			
	Optionen	-SSM (24V DC)		
	Bemessungsspannung	24 -48 V DC	110V – 240V AC	
	Spannungsbereich gemäß EN54-3	18V – 60V Option: -SSM: 18V – 30V	95V – 265V AC	
	Ton	konform zur Bauproduktenrichtlinie (89/106/EWG) 1200Hz-500Hz (Sägezahn/ Saw tooth) DIN/PFEER P.T.A.P. 500Hz-1200Hz (Ansteigender Ton/ Slow whoop) 825Hz (Dauerton/ Continuous) 660Hz (Unterbrochener Ton/ Intermittent) 800Hz/ 1000Hz (Wechselton/ Alternating) 544Hz/ 440Hz (NF S 32-001)		
	Signalisierungsbereich	EN54-3: siehe Dokumente 30305-005-1 (PA 10) und 30306-005-1 (PA 20)		
	Umweltschutzklasse	Typ B		
	Die Prüfung erfolgte unter Verwendung des mitgelieferten Membrannippels und der äußeren Befestigungsbohrungen.			
VdS	PA10/ PA 20, 110 – 230V AC:	PA10/ PA 20, 24 - 48V DC:	PA10-SSM, PA 20-SSM:	
	G212116	G212191	G212192	
	Daten siehe Bauproduktenverordnung (305/2011/EU)			
GL	61062-13 HH Umweltkategorie C, H, EMC1			
MED	61739-14 HH			
UL, cUL	UCST, UCST7, ULSZ, ULSZ7, UEES, UEES7 (weiterführende Informationen siehe Seite 7)			

Inbetriebnahme

Sicherheitshinweise:

- Der elektrische Anschluss darf nur von hierfür autorisierten Personen in Übereinstimmung mit den derzeit gültigen Vorschriften durchgeführt werden.
- Warnung vor gefährlicher hoher elektrischer Spannung.
- Vor dem Öffnen ist sicherzustellen, dass das Gerät nicht unter Spannung steht.
- Vor Inbetriebnahme ist die auf dem Typenschild angegebene Versorgungsspannung zu kontrollieren. Eine falsche Betriebsspannung kann zur Schädigung bzw. zur Zerstörung des Betriebsmittels führen.
- Bei der Installation ist darauf zu achten, dass die Anschlussleitung gegen Zug und Verdrehen abgesichert ist. Bitte beachten: Die Geräte sind nicht für einen ortsveränderlichen Einsatz bestimmt.
- WARNUNG: Bei Installation Verdrahtung entfernt von scharfen Kanten, Ecken und internen Komponenten.
- Die Öffnung des Schalltrichters darf insbesondere bei Verwendung im Außenbereich oder in staubreicher Umgebung nicht nach oben zeigen.
- Die Funktion des Gerätes ist nur gewährleistet, wenn Ober- und Unterteil korrekt zusammengefügt sind.

Bei Verwendung der Kombination mit der Leuchte (PA X 10-10; PA X 10-15; PA X 20-10; PA X 20-15):

- Um eine Beeinträchtigung des Sehvermögens zu verhindern, ist der dauernde, direkte Blick in die aktivierte Leuchte zu vermeiden.

Öffnen des Gehäuses:

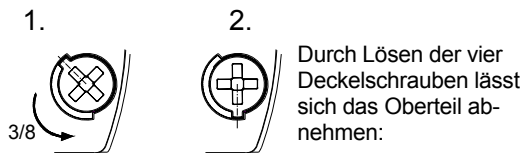

Verschließen des Gehäuses

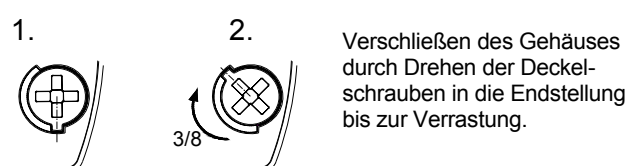

Das Gerät wird in nicht verschlossenem Zustand ausgeliefert.
Plombierstopfen für die Gehäuseschrauben sind als Zubehör erhältlich.

Kabeldurchführungen

Zur Sicherstellung der angegebenen Schutzart sind an den dafür vorgesehenen Durchbrüchen Kabeldurchführungen mit einer Schutzart von IP 66 zu montieren. Der mitgelieferte Membrannippel kann durch eine Kabelverschraubung oder durch einen M12-Steckverbinder mit einem Flanschmaß von M20 ersetzt werden.

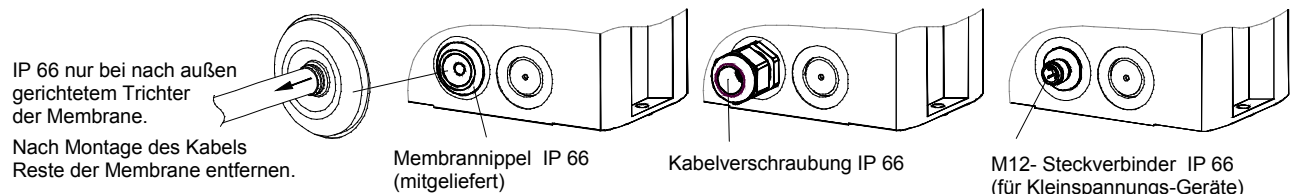

Anschlussplatine im Unterteil:

Elektrischer Anschluss und Tonauswahl durch externe Ansteuerung C1 und C2

Betriebsspannungsanschluss Schallgeber:

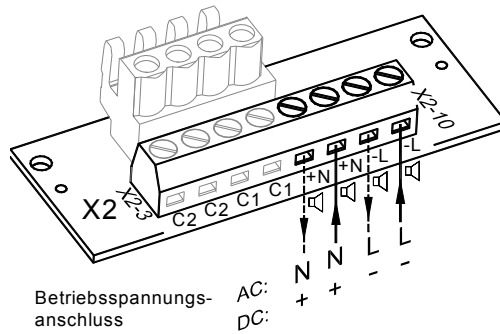

Betriebsspannungsanschluss Schallgeber-Blitzleuchten-Kombination:

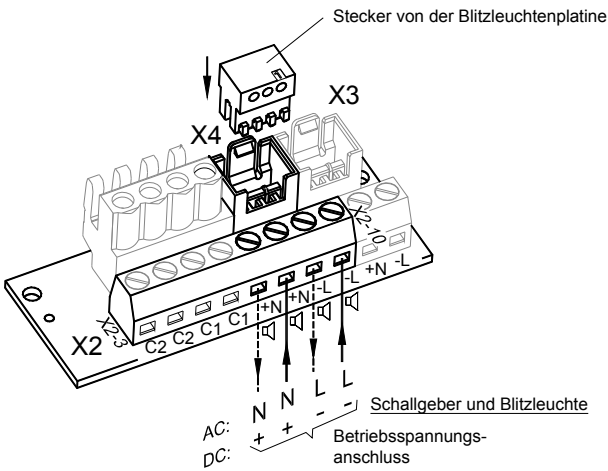

Gemeinsamer Anschluss von Blitzleuchte und Schallgeber (Auslieferungszustand)

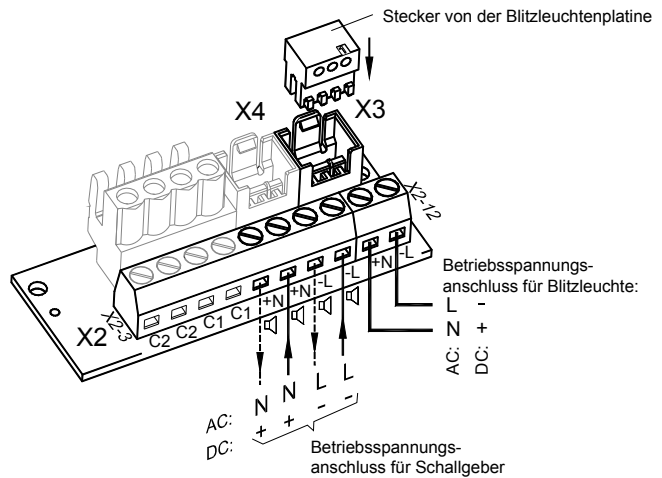

getrennter Anschluss von Blitzleuchte und Schallgeber

Der gewünschte Ton kann mithilfe des Tonartenschalters S3 (auf der Treiberplatine im Oberteil) ausgewählt werden. Die möglichen Töne sind in der Tonartentabelle im Anhang beschrieben. Nach Anlegen der Versorgungsspannung wird der Ton erzeugt.

Schallgeber-Treiberplatine (im Oberteil):

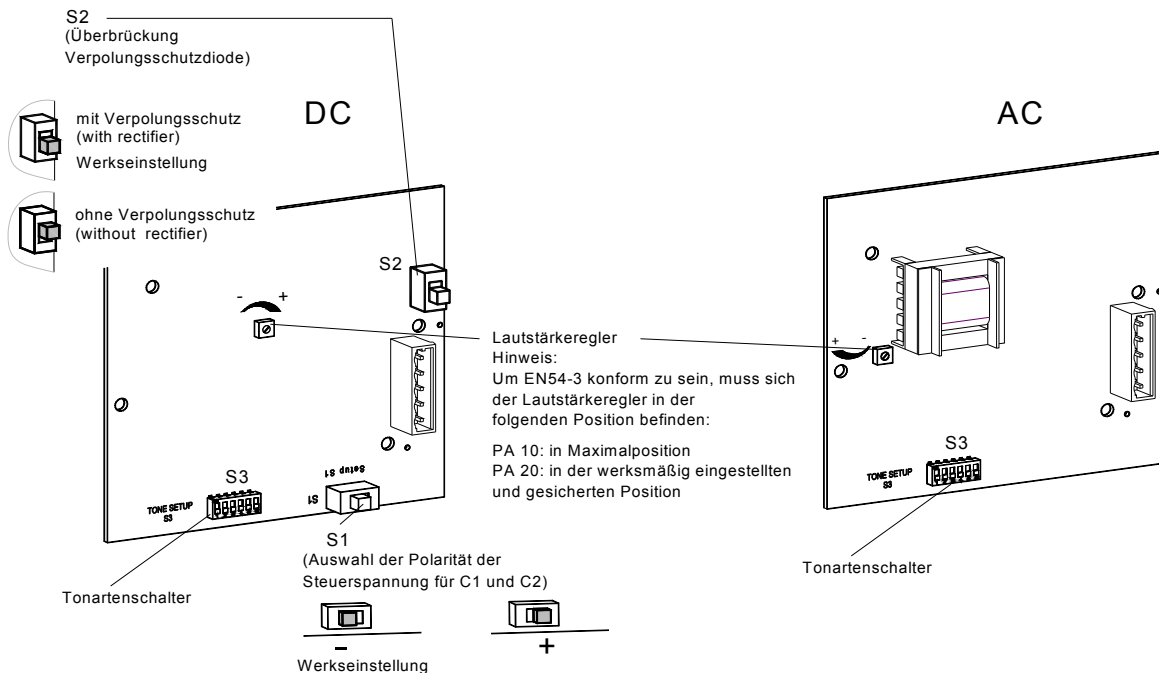

Änderung der Töne durch externe Ansteuerung

Für Anwendungen, die zusätzlich zum Grundton weitere Töne benötigen, besteht die Möglichkeit, bis zu drei weitere Tonarten mithilfe der folgenden elektrischen Ansteuerungen zu erreichen. Grundsätzlich wird erst der gewünschte Grundton ♪ (siehe Tonartentabelle im Anhang) mit dem Tonartenschalter S3 auf der Treiberplatine eingestellt. Die korrespondierenden zusätzlichen Töne (C1, C2, C1+C2) sind der Tabelle „Ansteuerung der Töne“ im Anhang zu entnehmen.

Tonstufenauswahl durch Steuereingang (TAS)

DC-Version:

Bei polrichtiger Anwendung erfolgt die Tonauswahl über die Steuereingänge C1 und C2 auf der Anschlussplatine. Die Versorgungsspannung muss dabei immer zusammen mit den Steuereingängen angelegt werden. Schalter S2 auf der Treiberplatine ist in der Stellung mit Verpolungsschutz (with rectifier).

Über den Schalter S1 auf der Treiberplatine erfolgt die Auswahl der Polarität der Steuerspannung („+“ oder „-“).

„+“: positive Ansteuerung

„-“: negative Ansteuerung (Werkseinstellung)

Achtung: Ist die Steuerspannung größer als die Versorgungsspannung oder die Versorgungsspannung liegt nicht an, erfolgt die Betriebsstromversorgung über die Steuereingänge. Eine entsprechende Belastbarkeit muss dann gewährleistet sein.

AC-Version:

In der AC-Version erfolgt die Tonauswahl durch Anschließen der Phase „L“ der Versorgungsspannung an die Steuereingänge C1 bzw. C2.

Die Versorgungsspannung muss dabei immer zusammen mit den Steuereingängen angelegt werden.

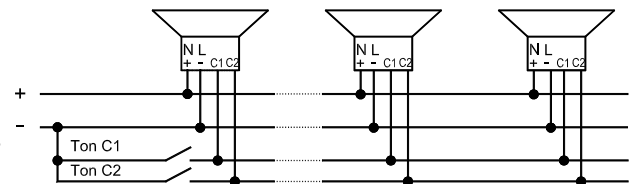
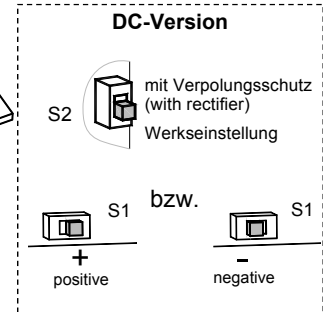
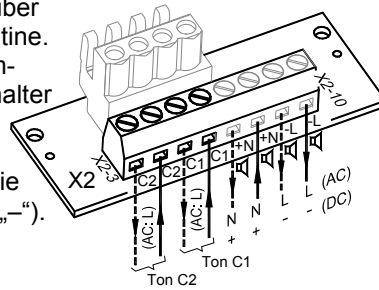

Beispiel für DC "–" -Ansteuerung

Tonstufenauswahl durch Versorgung über Steuereingang (TAV) - für alle DC-Versionen

Der Schallgeber kann über die Steuereingänge C1 bzw. C2 auf der Anschlussplatine mit Betriebsspannung versorgt werden. Versorgung und Tonstufenauswahl erfolgt somit gleichzeitig.

Der Minuspol des Schallgebers muss angeschlossen sein. Durch Anschließen der positiven Spannung an den Pluspol der Anschlussplatine wird der Grundton (♪) erzeugt; durch Anschluss an C1 bzw. C2 wird die entsprechende Tonstufe ausgewählt.

Durch gleichzeitiges Anschließen der positiven Spannung an C1 und C2 wird die Tonstufe „C1+C2“ gewählt. Der Schalter S1 auf der Treiberplatine muss auf „+“ stehen.

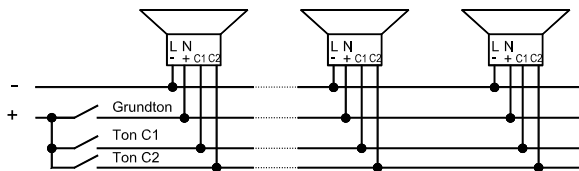
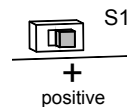
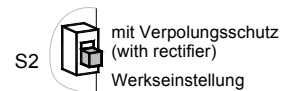
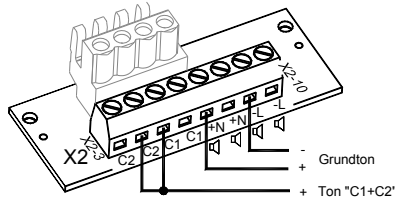
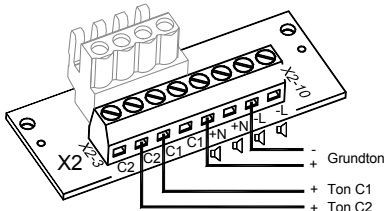

Anschlussbeispiel





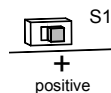
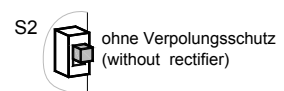
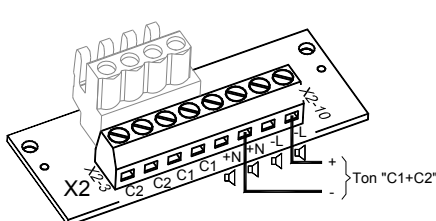
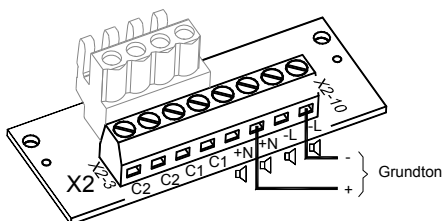

Tonstufenauswahl durch Verpolung (TAR) - für alle DC-Versionen (außer Option –SSM)

Steht der Schalter S2 auf der Treiberplatine in der Stellung „ohne Verpolungsschutz = without rectifier“, kann durch Verpolung der Betriebsspannung zum Grundton (♪) zusätzlich Ton „C1+C2“ gewählt werden. Der Umschalter S1 muss auf „+“ geschaltet werden. Die Steuereingänge C1 und C2 dürfen auf der Anschlussplatine nicht beschaltet werden.



Option –SSM (Soft-Start-Modul) (nur 24V DC):

Begrenzung der Einschaltstromspitze auf:

PA 10-SSM:	 : max. 2,1 A	
PA 20-SSM:	 : max. 4,5 A	
PA X 10-xx-SSM:	 : max. 2,1 A	 : max. 4,5 A
PA X 20-xx-SSM:	 : max. 4,5 A	 : max. 4,5 A

- Durchschalten der Betriebsspannung zum Betriebsmittel erst ab >7V
- Widerstand zur Leitungsüberwachung angeschlossen

Betriebsspannungsbereich: 18V – 30V DC

Widerstand zur Leitungsüberwachung:

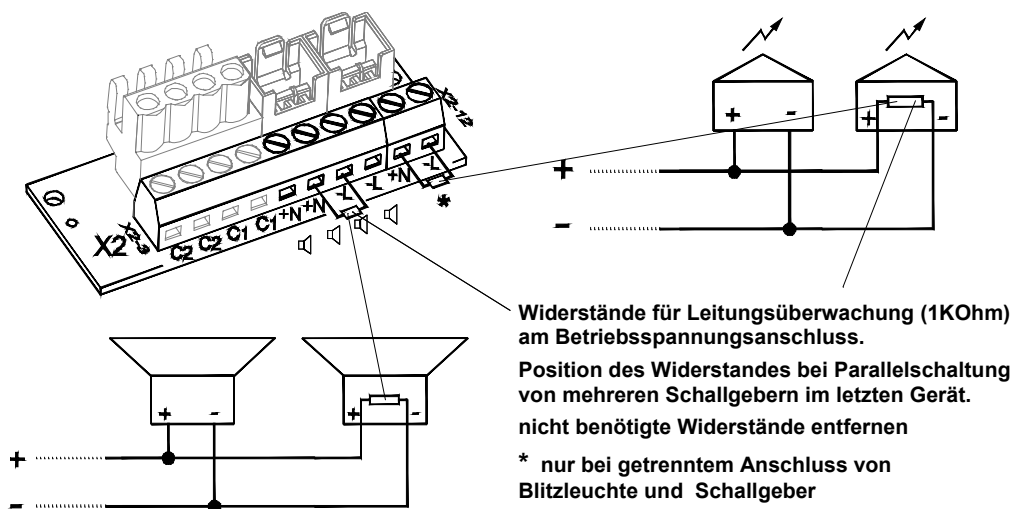

Wartung, Service, Instandhaltung

Das Gerät erfordert keine besondere Wartung. Die äußere Reinigung sollte mit einer schwachen Seifenlösung ohne Verwendung von Lösungsmittel erfolgen. Der Schallgeber darf nur in unbeschädigtem Zustand innerhalb der spezifizierten Kenndaten betrieben werden. Umbauten, Änderungen, fehlerhafter und unzulässiger Einsatz sowie die Nichtbeachtung der Hinweise dieser Betriebsanleitung schließen eine Gewährleistung aus. Ein Austausch von Komponenten darf nur mit Originalersatzteilen erfolgen. Reparaturen sind grundsätzlich im Herstellerwerk auszuführen.

PA 10/20

PA X 10-10/ PA X 10-15

PA X 20-10/ PA X 20-15

Operating and installation instruction

Dimensions

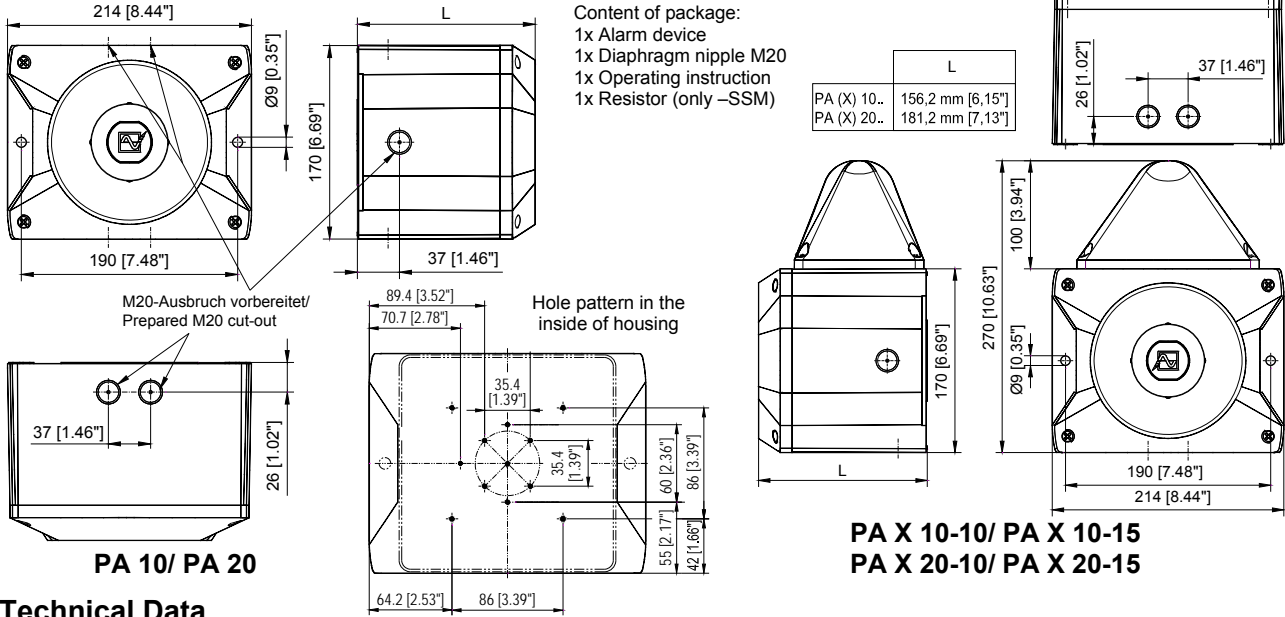

Technical Data

	PA 10	PA 20	PA X 10-10	PA X 10-15	PA X 20-10	PA X 20-15
Nom. sound level	110dB (A) 1m	120dB (A) 1m	110dB (A) 1m		120dB (A) 1m	
Volume control	-10dB	-9dB	-10dB		-9dB	
Tones	80					
Flash energy	-		10J	15J	10J	15J
Flash frequency	1Hz					
Rated voltage (limits see approvals)	24 V DC or 12-48V DC 24V AC	24V AC 110 – 240 V AC 50/60 Hz	24 V DC oder 12-48V DC 24V AC	110 – 240 V AC 50/60 Hz 12V DC	12V DC 24V DC	48V DC 24V AC 115V AC 230V AC
Operating voltage range	10 – 60 V DC 20 – 30V AC	95 – 265 V AC 10 – 60 V DC 20 – 30V AC	95 – 265 AC 10,5 – 15 V 18V – 30V	10,5 – 15 V 18V – 30V 40V – 60V	20 – 30V 95V – 127V 195V – 253V	10,5 – 15 V 18V – 30V 40V – 60V 20 – 30V 95V – 127V 195V – 253V
Current consumption Sounder (max.) [mA]	24V: 360 485	850	140	24V: 800 880	1600	330
Current consumption Beacon (max.) [mA]	-	-	-	1400	680	300
Power consumption	24V: 8,5 W 12-48V: 9W	17,5 VA 15,5 VA	24V: 24,5 W 12-48V: 27W	17,5 VA 50 VA	22 W 22 W 32 W 54,5 VA 34,5 VA 40,5 VA	29 W 27,5 W 32,5 W 57 VA 45 VA 65,5 VA 27,5 W 38 W 50,5 W 80 VA 62,5 VA 72 VA 35 W 43,5 W 51 W 82,5 VA 72,5 VA 97 VA
Duty cycle	100%					
Connection terminal	0,14 - 2,5mm ² / AWG24 - AWG 14 (stranded)					
Ingress protection	IP66 (EN60529), Type 4 & 4x					
Resistance against impact	IK08 (EN50102)					
Protection class	II Double insulated equipment					
Operating temperature	-40°C...+55°C					
Storage temperature	-40°C...+70°C					
Max. rel. Humidity	90%					
Cable entry	7x M20 (prepared)		5x M20 (prepared)			
Sealing range of grommet	7 – 13 mm					
Material of housing	With the use of cable diameters <7mm, a cable screw joint with sufficient ingress protection must be provided PC/ABS Blend					
Material of lens	PC					
Installation position	arbitrarily					
Options	-SSM, (see page 11)					
Accessory	Sealing plug (Art-no. 28300000002)					
Lens colours	-		clear, white, yellow, amber, red, green, blue			

Approvals (valid for marked equipment)

Construction Product Regulation (305/2011/EC) 	PA10/ PA 20, 110-230V AC:		PA10/ PA 20, 24-48V DC:		PA10-SSM, PA 20-SSM:	
	VdS 0786-CPD- 21184		VdS 0786-CPD- 21223		0786-CPD- 21224	
					PA 10/ PA 20	
					-SSM (24V DC)	
	Options					
	Rated voltage		24 – 48 V DC		110V – 240V AC	
	Operating voltage range acc. to EN54-3, EN54-23		18V – 60V Option: -SSM (18V – 30V)		95V – 265V AC	
	Tone		Compliant with the Construction Product Directive (89/106/EWG) 1200Hz-500Hz (Saw tooth) DIN/PFEER P.T.A.P. 500Hz-1200Hz (Slow whoop) 825Hz (Continuous) 660Hz (Intermittent tone) 800Hz/ 1000Hz (Alternating tone) 544Hz/ 440Hz (NF S 32-001)			
2						
15						
60						
104						
131						
146						
Signaling area		EN54-3: see documents 30305-005-1 (PA 10) and 30306-005-1 (PA 20)				
Environmental protection class		Type B				
Testing takes place using the supplied diaphragm nipple and the outer fastening bores.						
VdS	PA10 / PA 20, 110 – 230V AC:		PA10/ PA 20, 24 - 48V DC:		PA10-SSM, PA 20-SSM:	
	G212116		G212191		G212192	
	Data see Construction Product Regulation (305/2011/EC)					
GL	61062-13 HH Environmental Category C, H, EMC1					
MED	61739-14 HH					
UL, cUL		Rated voltage	Audible Signal Appliance Fire Alarm Equipment ULSZ, ULSZ7		Audible and Visual Signal Appliance General Signal Equipment UCST, UCST7 and UEES, UEES7	
	PA 10 PA 20	24V – 48V DC (Fire Alarm Equipment) 12V – 48V DC (General Signal Equipment)	x Special application, limited operating voltage range 18 – 60V DC		x	
	PA 10 PA 20	24V AC 110 – 240V AC	-		x	
	PA X 10 .. PA X 20 ..	115V AC 230V AC 24V AC 12V DC 24V DC 48V DC	-		x	

PATROL sounders and combined units **PA 10/ PA 20/ PA X 10../ PA X 20..** comply with the limits for a Class B digital device, pursuant to part 15 of the FCC Rules.

UL/ cUL specifications:

Inrush current	PA 10, PA 20	Surge Current Peak	Surge Current RMS (16,7ms frame)	Voltage
	24 – 48 V DC	27 A	4,5 A	60 V DC
	24 V AC	11,5 A	6,8 A	30 V AC
	110 – 240 V AC	18,5 A	1,45 A	265 V AC

Suitable for indoor and outdoor use.

Signaling area: see document 30305-005-1 (PA 10) and 30306-005-1 (PA 20)

Cable gland entries:

Conduit installation needs to be UL/ cUL listed fittings suitable for knockout openings. The supply wiring has to be enclosed in metal conduits for products for Fire Alarm Use.

Installation:

The units shall be installed indoors or outdoors in accordance with the manufacturer's installation instructions as well as the National Electrical Code (NFPA 70) and the National Fire Alarm Code (NFPA 72) for the units evaluated for Public Fire Alarm applications in the U.S. In Canada, they shall be installed in accordance with the Canadian Electrical Code, Part 1 and the Standard for the Installation of Fire Alarm Systems CAN/ULC-S524-M91 for the units evaluated for Public Fire Alarm applications. The installation shall also be in a manner acceptable with the local authority having jurisdiction.

For audible application for Fire Alarm Service use both terminals for connection. Break wire run to provide Electrical Supervision (see UL 464 clause 39.1e). The tone no. 111 is to be used for evacuation use only (see UL 464 clause 39.1e)

Volume control: PA 20/ PA X 20 ... The volume control has to be set to the secured factory position.

cUL directional characteristics for the horn:

AXIS	LE	dB(A)
Horizontal	32 deg. left or right	-3
Horizontal	28 deg. left or right	-6
Vertical	32 deg. left or right	-3
Vertical	28 deg. left or right	-6

Min. Output sound pressure level: [dB(A)]

(Tone no. 2, 15, 60, 104, 131, 146, 111, 112, and 113 was used for this test.)

Type	Voltage	UL 464 db(A) at 10 ft ++	CAN/ULC-S525-07
PA 10 (24-48 DC)	18V DC	82,4 (for tone 113)	92,4 (for tone 111)
PA 20 (24-48 DC)	18V DC	84,3 (for tone 113)	99,3 (for tone 111)

Connecting cables:



Taking into operation

Safety notes:

- Installation must be carried out by an electrician in compliance with the latest codes and regulations.
- Danger: High voltage may be present.
- Prior to opening, it must be ensured that no voltage is applied to the device.
- Before electrical connection, the supply voltage on the type plate is to be checked. The wrong operating voltage can lead to damages or to the destruction of the equipment.
- During installation it must be ensured that the connection cables are secured against tension and distortion. Please observe: The devices are not designed for portable use.
- CAUTION: When making installation, route field wiring away from sharp projections, corners and internal components.
- The opening of the bell mouth must not point upwards, especially in the case of use outdoors or in a particularly dusty environment.
- The function of the unit is only guaranteed if the upper and lower section is joined correctly.

When using the sounder –beacon combination (PA X 10-10; PA X 10-15; PA X 20-10; PA X 20-15):

- In order to prevent detriment to sight, continuously looking directly in the activated light is to be avoided.

Opening the housing:

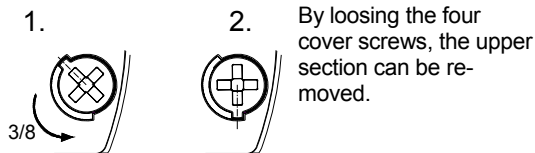

Closing the housing

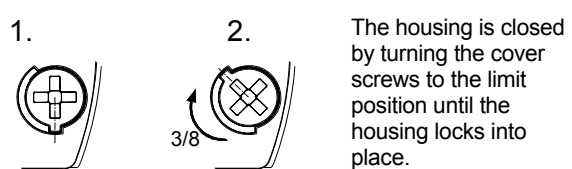

The unit is not closed when delivered.

Sealing plugs for the housing screws are available as accessories.

Cable gland entries

To guarantee the specified protection type, cable grommets with a protection type of IP 66 are to be installed at the openings provided for this purpose. The supplied diaphragm nipple can be replaced with a cable gland or with an M12 plug connection with a flange measurement of M20.

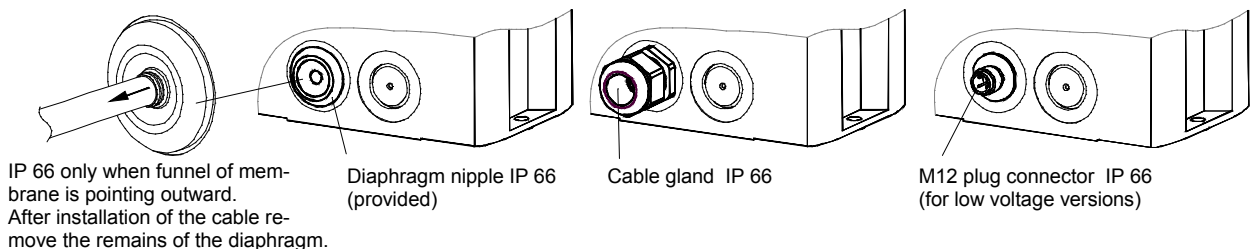

Circuit board for electrical connection (located in the base section):

Electrical connection and tone selection using external control C1 and C2

Terminal for operating voltage - Sounder:

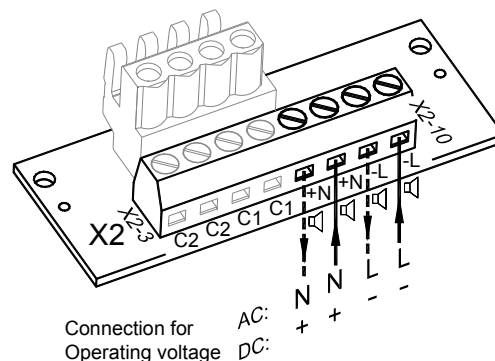

Terminal for operating voltage - Sounder-beacon combination:

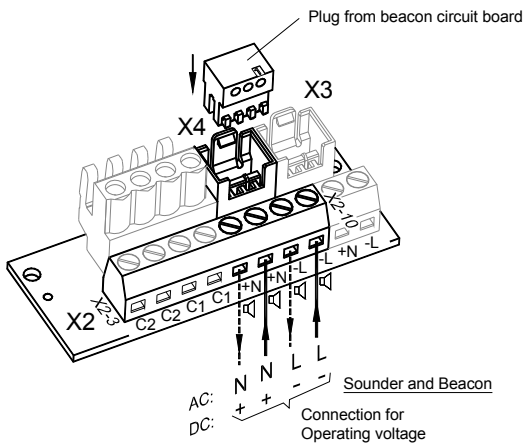

Common connection of beacon and sounder (Delivery status)

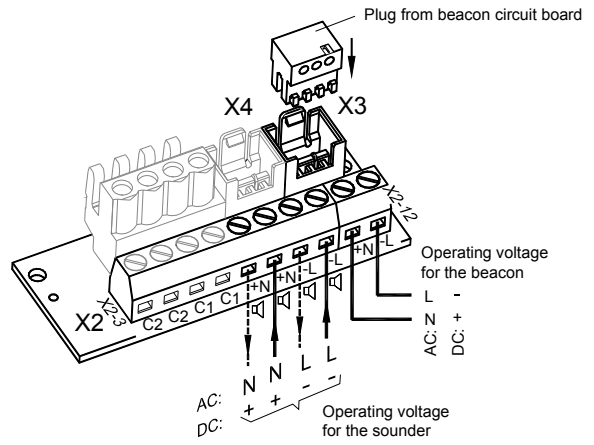

Separate connection of beacon and sounder

The desired tone can be selected using the tone selector switch S3 (on the driver circuit board). The available tones are described in the tone table in the appendix. After establishing the supply voltage the tone is generated.

Driver circuit board of sounder (located in the upper section):

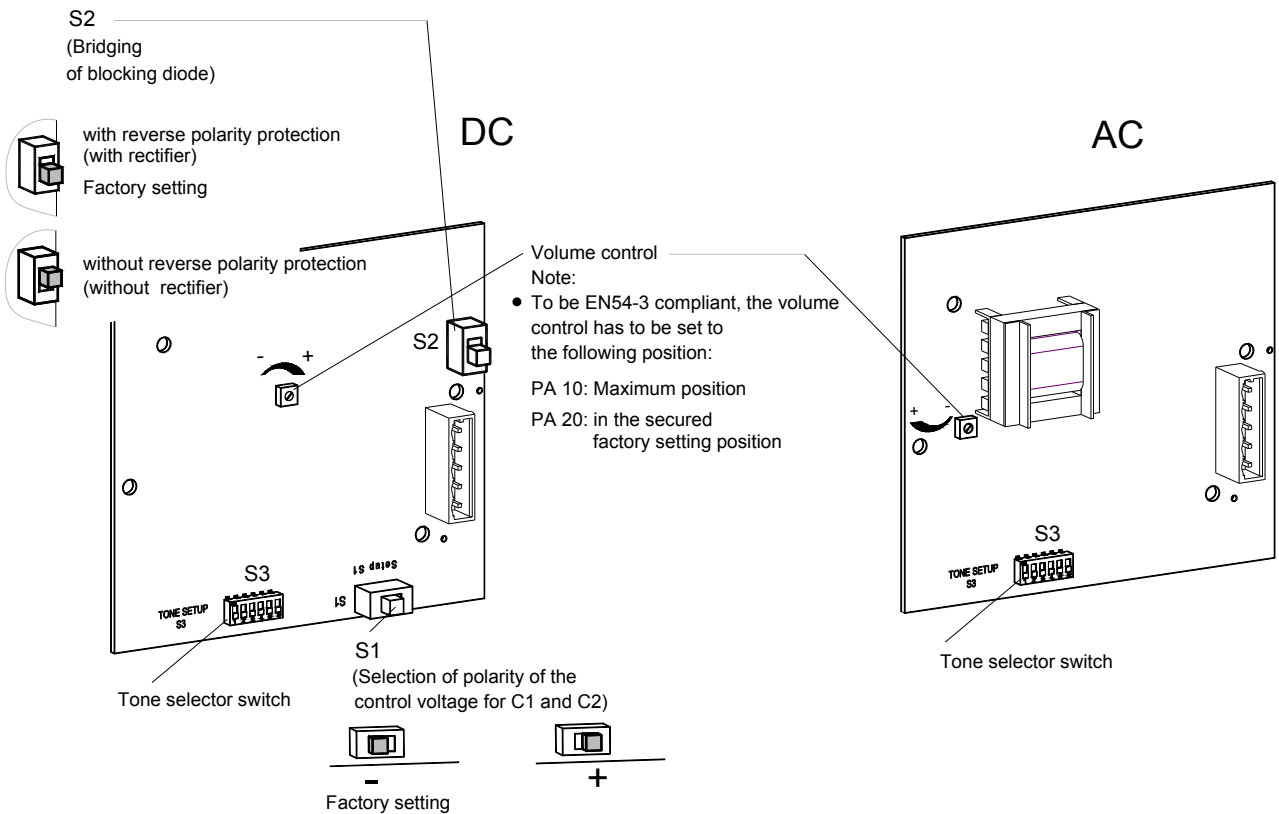

Change of the tones by external control

For applications which require more tones than just the base tone, it is possible to provide up to three additional tone types with the use of the following electrical controls.

As a basic rule, the desired base tone (J, see tone table in the appendix) is set with the tone selector switch S3 on the driver board. The corresponding additional tones (C1, C2, C1+C2) can be gathered from the table "Selection of the tones".

Tone selection with control input (TAS)

DC-Version:

When used with correct polarity, the tone selection takes place through the control inputs C1 and C2 on the circuit board. In the process, the supply voltage must always be applied together with the two control inputs. Setting of switch S2 in position "with rectifier"

= with reverse polarity protection.

The selection of the polarity of the control voltage ("+" or "-") takes place with the switch S1 on the driver board.

"+": positive control

"-": negative control (factory setting)

Caution: If the control voltage is greater than the supply voltage or the supply voltage is not applied, the operating current supply is provided through the control inputs. A corresponding load capacity must then be guaranteed.

AC-version:

In the AC version the tone selection takes place by connecting the phase "L" of the supply voltage to the control inputs C1 and C2. In the process, the supply voltage must always be applied together with the two control inputs.

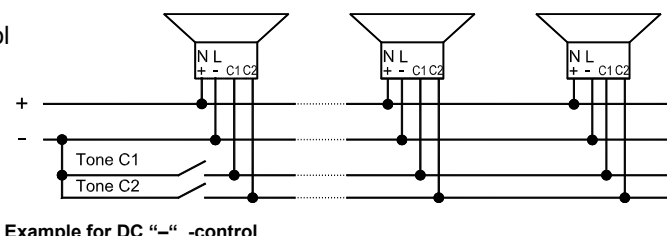
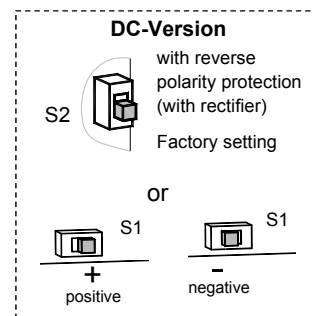
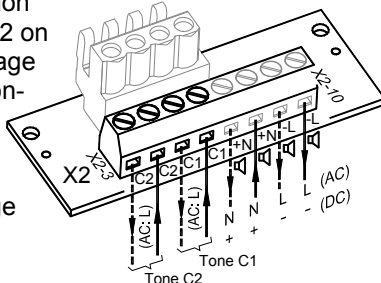

Example for DC "-" -control

Tone selection with supply through control input (TAV) - for all DC versions

The sounder can be supplied with operating voltage through the control inputs C1 and C2 on the circuit board. Supply and tone selection thus take place simultaneously.

The minus pole of the sounder must be connected. With connection of the positive voltage to the plus pole of the circuit board, the base tone (J) is generated; with connection to C1 or C2 the corresponding tone is selected. With simultaneous connection of the positive voltage to C1 and C2 the tone "C1+C2" is selected. The switch S1 on the driver board must be set to "+".

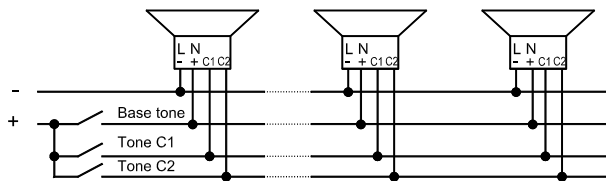
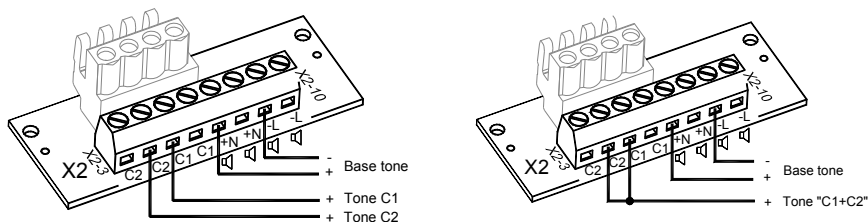

Connection example

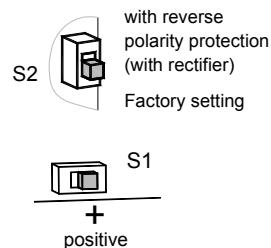





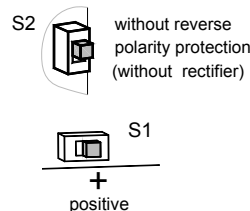
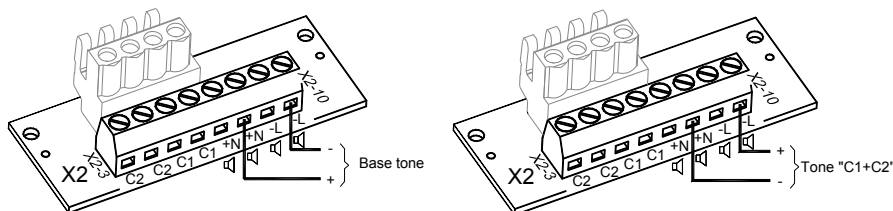

Tone selection through pole reversal (TAR) - for all DC versions except for option -SSM

If the switch S2 on the driver board is in the position "without reverse polarity protection = without rectifier", the tone "C1+C2" can be selected in addition to the base tone through pole reversal. The switch S1 must be set to "+". The control inputs C1 and C2 may not be switched on the circuit board.



Option –SSM (Soft-Start-Module) (24V DC only):

- Limitation of start-up peak:

PA 10-SSM:	 : max. 2,1 A	
PA 20-SSM:	 : max. 4,5 A	
PA X 10-xx-SSM:	 : max. 2,1 A	 : max. 4,5 A
PA X 20-xx-SSM:	 : max. 4,5 A	 : max. 4,5 A

- Switching through the operating voltage to equipment: above 7V

- Resistor for line monitoring mounted

Operating voltage range: 18V – 30V DC

Connection of a resistor for line monitoring:

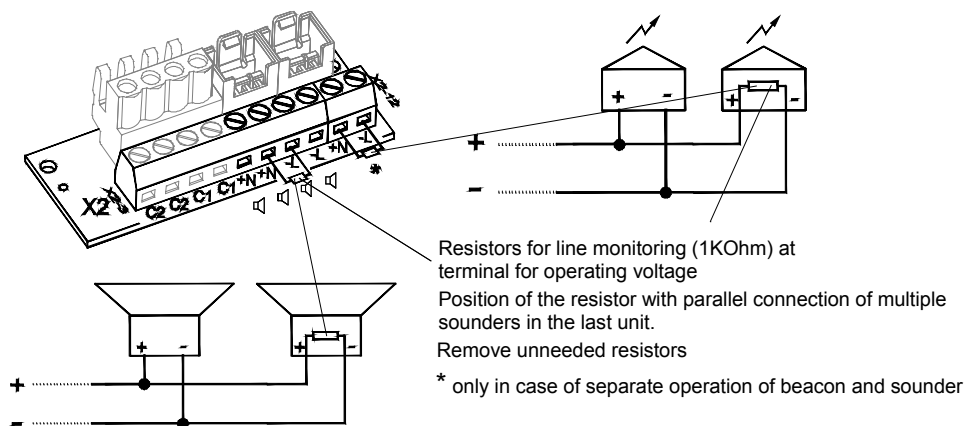

Maintenance, Service and Ordering Spare Parts

The device does not require any special maintenance.

External cleaning should be done with a mild soap solution without the use of solvents.

The device may only be operated in the undamaged state within the specified rating.

Conversions, alterations, improper and inadmissible use as well as the non-observance of the notes in these operating instructions shall render the warranty null and void.

Components may be replaced only by original spare parts.

As a matter of principle, repairs are to be carried out in the manufacturing works.

PA 10/20

PA X 10-10/ PA X 10-15

PA X 20-10/ PA X 20-15

Instructions d'utilisation et de montage

Dimensions

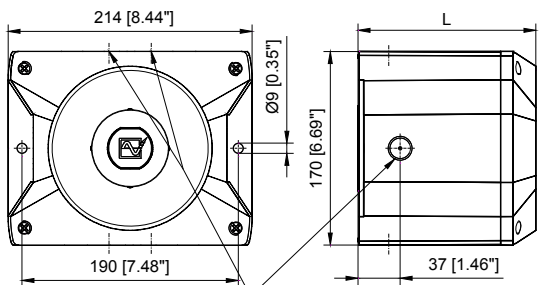

- Contenu de l'emballage :
- 1 alarme
 - 1 raccord fileté à membrane M20
 - 1 instruction d'utilisation
 - 1 résistor (seulement -SSM)

	L
PA (X) 10..	156,2 mm [6,15"]
PA (X) 20..	181,2 mm [7,13"]

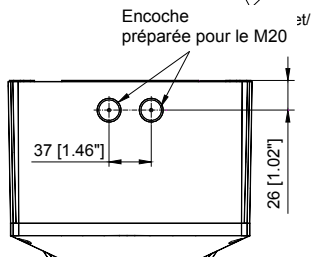
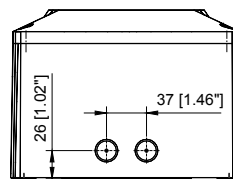

PA 10/ PA 20

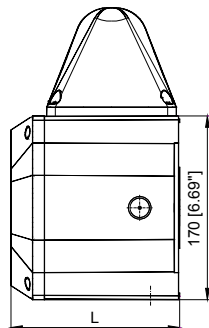
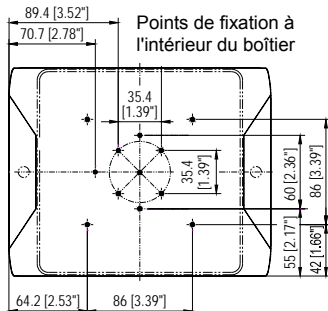

**PA X 10-10/ PA X 10-15
PA X 20-10/ PA X 20-15**

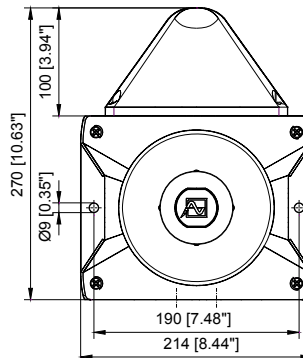

Caractéristiques techniques

	PA 10	PA 20	PA X 10-10	PA X 10-15	PA X 20-10	PA X 20-15
Niveau sonore nom.	110dB (A) 1m	120dB (A) 1m	110dB (A) 1m		120dB (A) 1m	
Réglage du volume	-10dB	-9dB	-10dB		-9dB	
Sons	80					
Puissance lumineuse	-		10J	15J	10J	15J
Fréquence du flash	1Hz					
Tension de service (Limitations voir admissions)	24 V CC ou 11-48V CC 24V CA	110 - 240 V CA 50/60 Hz 24 V CC ou 12-48V CC 24V CA	110 - 240 V CA 50/60 Hz 12V CC	12V CC	24V CC	24V CC
Plage de la tension de service	10-60V	20-30V 95-265V	10-60V	20-30V 95-265V	10,5-15V	18-30V
Courant nominal admis par la sirène (max.) [mA]	24V: 360 485	850	140	24V: 800 880	1600	330
Courant nominal admis par le flash (max.) [mA]	-	-	-	-	1400	680
Puissance	24V: 8,5 W 12-48V: 9W	17,5 VA	15,5 VA	24V: 24,5 W 12-48V: 27W	17,5 VA	50 VA
Facteur de marche	100%					
Bornes de connexion	0,14 - 2,5 mm ² en fils de faible diamètre/ AWG24 - AWG 14 (stranded)					
Type de protection	IP66 (EN60529), Type 4 & 4x					
Résistance aux chocs	IK08 (EN50102)					
Classe de protection	II					
Temp. de service	-40°C...+55°C					
Temp. de stockage	-40°C...+70°C					
Humidité relative max.	90%					
Entrée de câbles	7x M20 avec empreinte préalable			5x M20 avec empreinte préalable		
Zone d'intensité du profilé de protection	7 - 13 mm En cas d'utilisation de câbles de diamètre < 7 mm, un raccord de câble équipé d'un type de protection suffisant sera à prévoir					
Matériau du boîtier	Mélange PC/ABS					
Matériau du capot	PC					
Position de montage	quelconque					
Options	-SSM (voir page 16)					
Accessoires	Bouchon de plombier (art. n° 2830000002)					
Couleurs du capot	- transparent, blanc, jaune, orange, rouge, vert, bleu					

Admissions

Admissions (valable pour les appareils signalés)				
Règlement sur les produits de construction (305/2011/CE)	PA10/ PA 20, 110-230V AC:	PA10/ PA 20, 24-48V DC:	PA10-SSM, PA 20-SSM:	
	VdS 0786-CPD- 21184	VdS 0786-CPD- 21223	0786-CPD- 21224	
	PA 10/ PA 20			
	- SSM (24V DC)			
	Options	24 – 48 V CC	110V – 240V CA	
	Tension de service	18V – 60V Option: -SSM (18V – 30V)	95V – 265V CA	
Plaque de tension de service selon EN 54-3	Conforme à la Directive sur les produits de construction (89/106/CEE) 1200Hz-500Hz (dent de scie DIN/PFEER P.T.A.P. 500Hz-1200Hz (son montant) 825Hz (son continu) 660Hz (son interrompu) 800Hz/ 1000Hz (son variable) 544Hz/ 440Hz (NF S 32-001)			
Son	2 15 60 104 131 146			
Plaque de signalisation	EN54-3: Voir les documents 30305-005-1(PA 10) et 30306-005-1 (PA 20)			
Classe de protection environnementale	Type B			
Le test a été effectué en utilisant le raccord fileté de membrane livré et les perçages extérieurs de fixation.				
VdS	PA10 / PA 20, 110 – 230V AC:	PA10/ PA 20, 24 - 48V DC:	PA10-SSM, PA 20-SSM:	
	G212116	G212191	G212192	
	Pour les caractéristiques voir le Règlement sur les Produits de construction (305/2011/CE)			
GL	61062-13 HH Catégorie environnementale C, H, EMC1			
MED	61739-14 HH			
UL, cUL	UCST, UCST7, ULSZ, ULSZ7, UEES, UEES7 (plus d'informations voir page 7)			

Mise en service

Consignes de sécurité :

- Le branchement électrique doit être effectué uniquement par des personnes autorisées conformément aux réglementations en vigueur.
 - Attention à la tension électrique élevée. Danger !
 - Avant d'ouvrir, il convient de s'assurer que l'appareil est hors tension.
 - La tension d'alimentation indiquée sur la plaque signalétique doit être vérifiée avant la mise en service. Une tension de service incorrecte peut entraîner un endommagement ou la destruction de l'appareil.
 - Il convient de veiller, lors de l'installation, que les cordons d'alimentation ne sont pas soumis à des contraintes de traction ou de torsion. Attention : les appareils ne sont pas destinés à une utilisation mobile.
 - AVERTISSEMENT : lors de l'installation, maintenir les câblages éloignés des bords coupants, coins et composants internes.
 - L'ouverture du pavillon ne doit pas être tournée vers le haut, notamment en cas d'utilisation à l'extérieur ou dans un environnement poussiéreux.
 - Le fonctionnement de l'appareil n'est garanti que si les parties supérieure et inférieure sont assemblées correctement.
- En cas d'utilisation de l'ensemble avec le feu flash (PA X 10-10; PA X 10-15; PA X 20-10; PA X 20-15) :
- Pour éviter un risque d'endommagement de l'acuité visuelle, il convient d'éviter le contact visuel direct et permanent avec la lampe.

Ouverture du boîtier

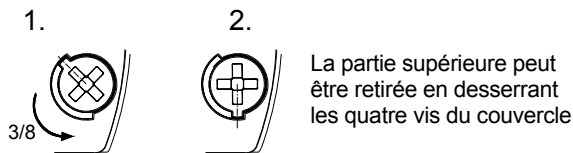

Fermeture du boîtier

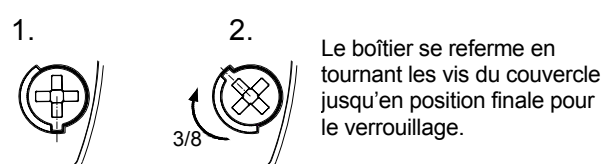

L'appareil est livré en état non verrouillé.

Des bouchons de plombier sont disponibles en accessoires pour les vis du boîtier.

Passages de câbles

Afin de garantir le type de protection indiqué, des passages de câbles d'une protection IP 66 doivent être montés au niveau des perçages prévus à cet effet. Le raccord fileté à membrane fourni peut être remplacé par un passe-câble à vis ou par un connecteur M12 avec une bride de dimension M20.

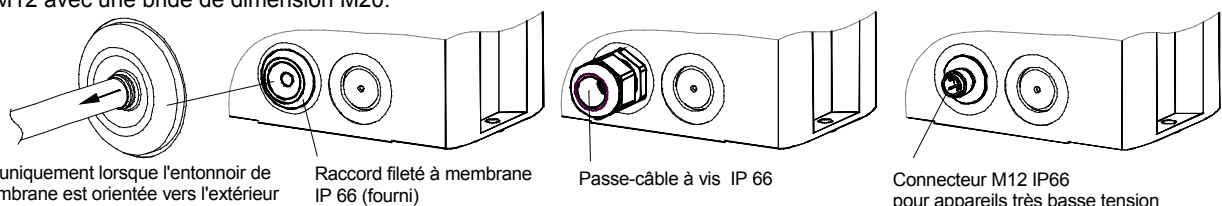

IP 66 uniquement lorsque l'entonnoir de la membrane est orientée vers l'extérieur

Raccord fileté à membrane IP 66 (fourni)

Passe-câble à vis IP 66

Connecteur M12 IP66 pour appareils très basse tension

Après le montage du câble, ôter le reste de la membrane

**Platine de raccordement dans la partie inférieure :
Branchement électrique et choix de la tonalité par activation externe C1 et C2**

Raccordement à la tension de service de la sirène :

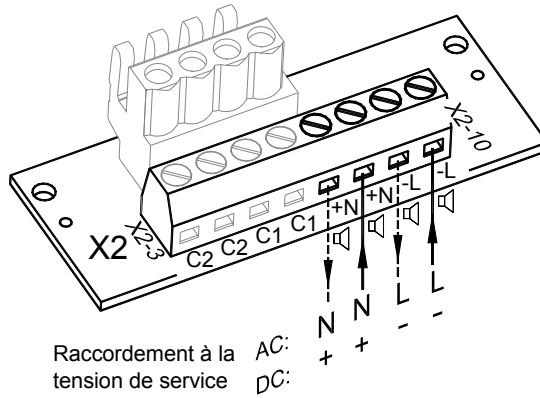

Raccordement à la tension de service de l'ensemble sirène-feu flash :

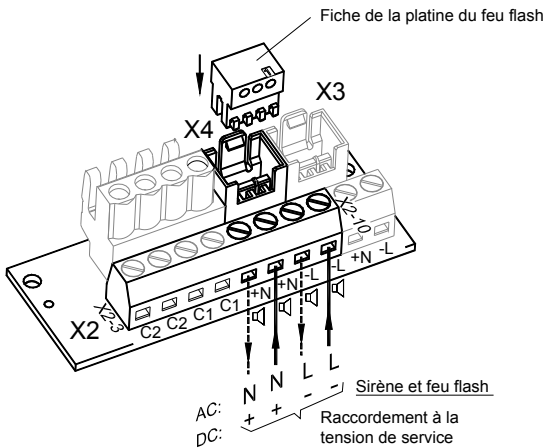

Raccordement commun
du feu flash et de la sirène
(État à la livraison)

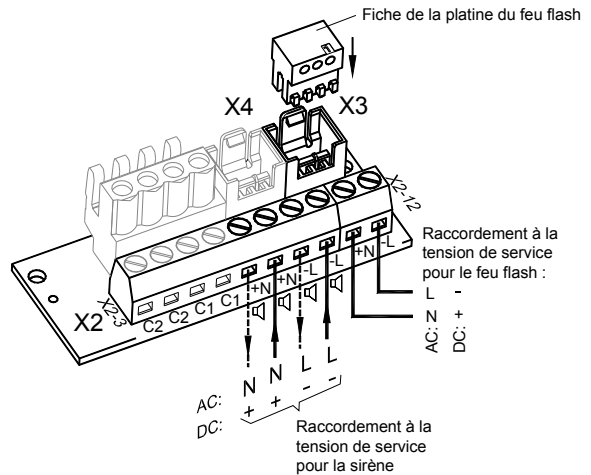

Raccordement séparé
du feu flash et de la sirène

Le son peut être sélectionné à l'aide de l'interrupteur de tonalité S3 (sur la platine pilote de la partie supérieure). Les sons possibles sont décrits dans le tableau des tonalités en Annexe. Le son est émis dès que la tension d'alimentation est appliquée.

Platine pilote de la sirène (partie supérieure) :

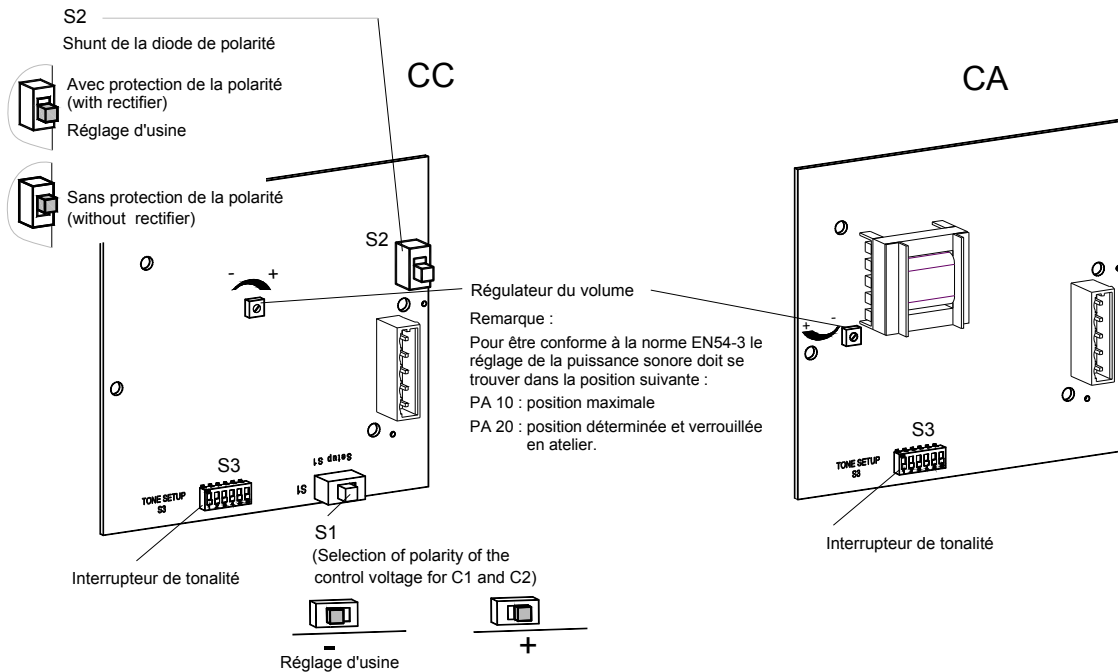

Modification des sons par activation externe

Pour les applications nécessitant d'autres sons que celle de base, il est possible d'obtenir jusqu'à trois autres sons à l'aide des activations électriques suivantes.

En principe, le son de base souhaitée (♯, voir le tableau des tonalités en annexe) est réglé en premier à l'aide de l'interrupteur de tonalité S3 sur la platine pilote. Les sons supplémentaires correspondants (C1, C2, C1 + C2) figurent dans le tableau « Activation des Sons » en annexe.

Sélections des tons par entrée de commande (TAS)

Version CC :

En cas d'application respectant la polarité, la sélection du son s'effectue par les entrées de commande C1 et C2 sur la platine de raccordement. La tension d'alimentation doit alors toujours être appliquée avec les entrées de commande. L'interrupteur S2 sur la platine pilote est en position avec protection de la polarité (with rectifier).

La sélection de la polarité de la tension de commande (« + » ou « - ») se fait à l'aide du commutateur S1 sur la platine pilote.

« + » : activation positive

« - » : activation négative (réglage usine)

Attention : Si la tension de commande est supérieure à la tension d'alimentation ou si la tension d'alimentation n'est pas appliquée, l'alimentation de service s'effectue par les entrées de commande. Une capacité correspondante doit alors être assurée.

Version CA :

En version CA, la sélection du son s'effectue en reliant la phase « L » de la tension d'alimentation aux entrées de commande C1 ou C2. La tension d'alimentation doit alors toujours être appliquée avec les entrées de commande.

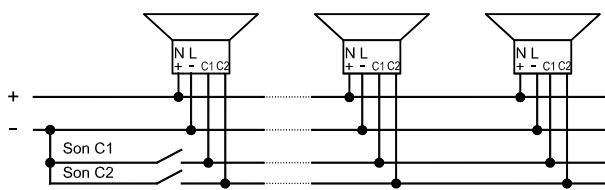
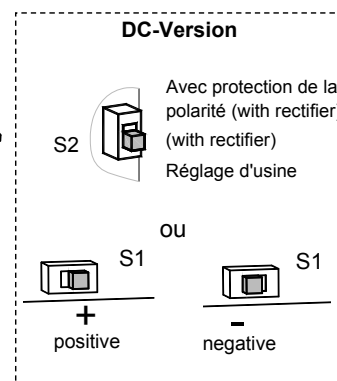
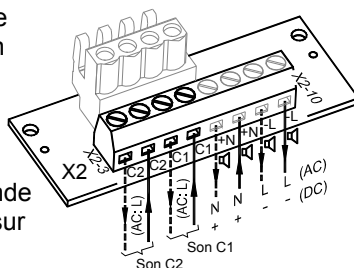

Exemple d'activation " ." (CC)

Sélection des tons par alimentation à l'aide de l'entrée de commande (TAV) – pour toutes les versions CC

La sirène peut être alimentée en courant de service par les entrées de commande C1 ou C2 sur la platine de raccordement. L'alimentation et la sélection des tons se font alors simultanément.

Le pôle négatif de la sirène doit être branché. Si la tension positive est branchée sur le pôle positif de la platine de raccordement, le son de base (♯) est émis ; si le branchement est effectué sur C1 ou C2, le ton correspondant est sélectionné.

Lorsque la tension positive est branchée simultanément sur C1 et C2, le ton « C1 + C2 » est sélectionné. Le commutateur S1 de la platine pilote doit être placé sur « + ».

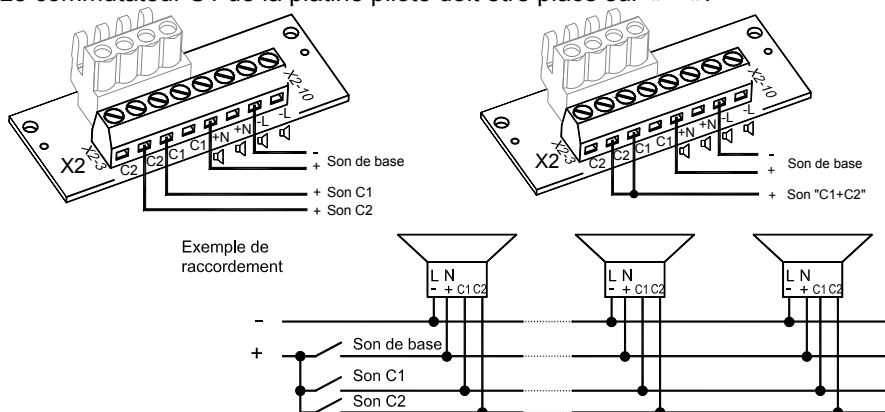

Exemple de raccordement

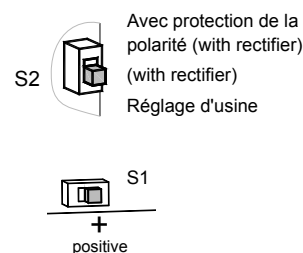

Sélection des tons par inversion de polarité (TAR) – pour toutes les versions CC

(Cette fonction n'est pas disponible avec les appareils équipés de l'option –SSM)

Si le commutateur S2 est en position « sans protection de la polarité = without rectifier » sur la platine pilote, le son « C1 + C2 » peut être sélectionné en plus de la tonalité de base (♯) par inversion de la polarité de la tension de service.





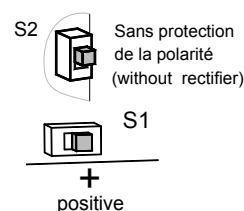
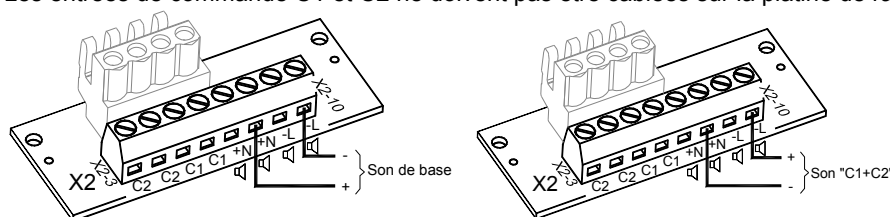

Le commutateur S1 doit être positionné sur « + ».

Les entrées de commande C1 et C2 ne doivent pas être câblées sur la platine de raccordement.



Option SSM (Module Soft-Start) (uniquement 24 V CC) :

- Limitation de la pointe du courant à l'enclenchement à :

PA 10-SSM:	 : max. 2,1 A	
PA 20-SSM:	 : max. 4,5 A	
PA X 10-xx-SSM:	 : max. 2,1 A	 : max. 4,5 A
PA X 20-xx-SSM:	 : max. 4,5 A	 : max. 4,5 A

- Transfert de la tension de service sur l'équipement à partir de > 7V
- Résistance à la direction des circuits intégrée

Plage de la tension de service : 18 V – 30 V CC

Résistance pour la surveillance de ligne

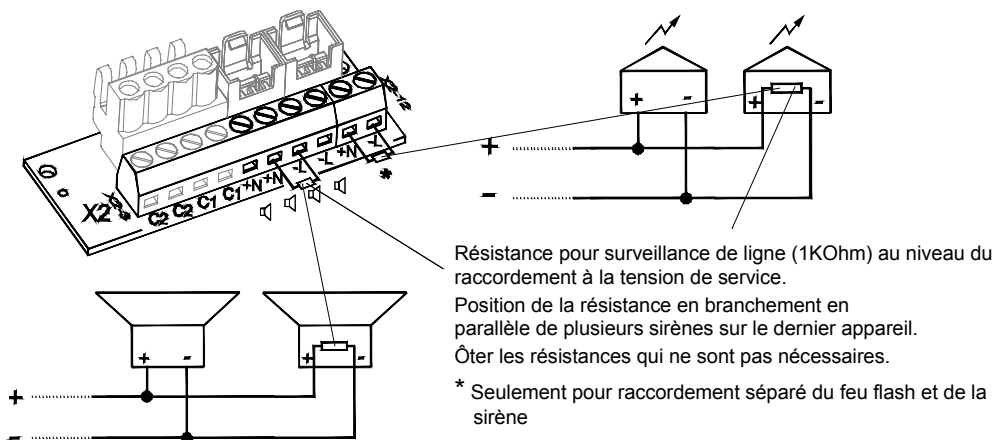

Maintenance, SAV, entretien

L'appareil ne requiert aucune maintenance particulière. Le nettoyage extérieur doit être effectué avec une solution légèrement savonneuse, sans solvants.

L'appareil doit être exploité uniquement en bon état de marche et dans le respect des caractéristiques indiquées. Toute transformation, modification, utilisation incorrecte ou inadmissible ainsi que le non-respect des instructions de service entraînent l'exclusion de la garantie.

Tous les composants doivent être remplacés uniquement par des pièces originales. Les réparations doivent en principe être effectuées dans les ateliers du fabricant.

PA 10/20

PA X 10-10/ PA X 10-15

PA X 20-10/ PA X 20-15

Инструкция по монтажу и эксплуатации

Размеры

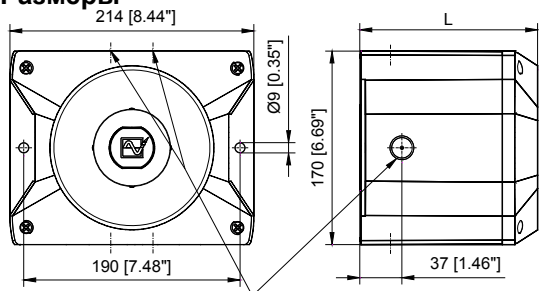

- Содержимое упаковки:
 1 устройство сигнализации
 1 мембранный ниппель M20
 1 руководство по эксплуатации
 1 резистор (только -SSM)

	L
PA (X) 10..	156,2 mm [6,15"]
PA (X) 20..	181,2 mm [7,13"]

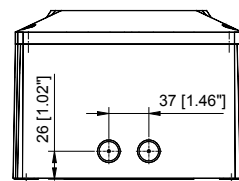

Отверстие M20 (подготовлено)

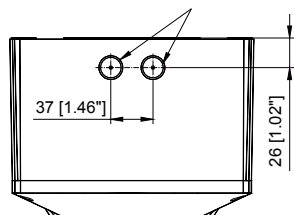

установка через скрытые внутренние отверстия

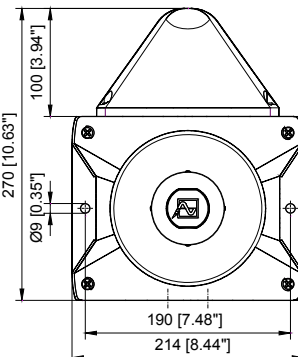
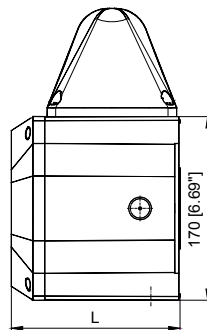

PA 10/ PA 20

**PA X 10-10/ PA X 10-15
PA X 20-10/ PA X 20-15**

Технические данные

	PA 10	PA 20	PA X 10-10	PA X 10-15	PA X 20-10	PA X 20-15
Ном. уровень звука	110 дБ (А) 1 м	120 дБ (А) 1 м	110 дБ (А) 1 м		120 дБ (А) 1 м	
Регулировка звука	-10 дБ	-9 дБ	-10 дБ		-9 дБ	
Тон	80					
Энергия вспышки	-		10 Дж	15 Дж	10 Дж	15 Дж
Частота вспышки	1 Гц					
Рабочее напряжение	24 В DC или 12-48 В DC 24В AC 50/60Гц	110 – 240 В AC 50/60Гц 24 В DC или 12-48 В DC 24В AC 50/60Гц	12 В DC 24 В DC 48 В DC 50/60Гц 24В AC 50/60Гц	115В AC 50/60Гц 230В AC 50/60Гц 12 В DC 24 В DC 48 В DC	24В AC 50/60Гц 115В AC 50/60Гц 230В AC 50/60Гц 12 В DC 24 В DC 48 В DC	24В AC 50/60Гц 115В AC 50/60Гц 230В AC 50/60Гц 12 В DC 24 В DC 48 В DC
Диапазон рабочего напряжения	10..60В 20..30В 95 – 265В	10..60В 20..30В 95 – 265В	10,5..15В 18..30В 40..60В 20..30В	95..127В 195..253В 10,5..15В 18..30В 40..60В	10,5..15 В 18..30В 40..60В 20..30В 95..127В 195..253В	10,5..15 В 18..30В 40..60В 20..30В 95..127В 195..253В
Номинальный ток, потребляемый излучателем звука (Макс) [mA]	24В: 360 12-48 В DC: 485 850 140	24 В: 800 12-48В: 880 1600 330	490 360 230 850	150 100 490 360 230 850 150 100	460 800 500 1600 330 200 460 800 500 1600 330 200	460 800 500 1600 330 200 460 800 500 1600 330 200
Номинальный ток, потребляемый проблесковой лампой (Макс) [mA]	-	-	1400 680 300 1400	300 300 1550 850 440 1400 330 160	1400 680 300 1400 300 1550 850 440 1400 300 160	1400 680 300 1400 300 1550 850 440 1400 300 160
Мощность	24 В: 8,5 Вт 12-48 В: 9 Вт 17,5 VA 15,5 VA	24 В: 24,5 Вт 12-48В: 27Вт 17,5 VA 50 VA	22 Вт 22 Вт 32 Вт 54,5 VA 34,5 VA 40,5 VA	29 Вт 27,5 Вт 32,5 Вт 57 VA 45 VA 65,5 VA 27,5 Вт 38 Вт 50,5 Вт 80 VA 62,5 VA 72 VA	38 Вт 50,5 Вт 80 VA 62,5 VA 72 VA 35 Вт 43,5 Вт 51 Вт 82,5 VA 72,5 VA 97 VA	38 Вт 50,5 Вт 80 VA 62,5 VA 72 VA 35 Вт 43,5 Вт 51 Вт 82,5 VA 72,5 VA 97 VA
Рабочий цикл	100%					
Соединения	0,14 - 2,5 мм ² , с тонким проводом / AWG24 - AWG 14 (многожильное)					
Тип защиты	IP66 (EN60529), Type 4 & 4x					
Ударная прочность	IK08 (EN50102)					
Класс защиты	II					
Рабочая температура	-40°C...+55°C					
Температура хранения	-40°C...+70°C					
Макс. отн. влажность воздуха	90%					
Кабельный ввод	M20, 7 шт, предварительно подготовлены		M20, 5 шт, предварительно подготовлены			
Область уплотнения проводной втулки	7 – 13 мм; при использовании кабеля диаметром менее 7 мм должна применяться резьбовая втулка с соответствующим классом защиты					
Материал корпуса	Поликарбонат/акрилонитрил-бутадиен-стирол					
Материал линзы	Поликарбонат					
Монтажное положение	Произвольное					
Опции	-SSM (см. стр. 21)					
Аксессуары	Пломбировочные пробки (арт. 28300000002)					
Цвет линзы	- прозрачная, белый, жёлтый, оранжевый, красный, зелёный, синий					

Допуски

Допуски (только для оборудования с маркировкой)				
Директива Европейского Союза по строительным изделиям (305/2011/CE) 	PA10/ PA 20, 110-230 AC:	PA10/ PA 20, 24-48 DC:	PA10-SSM, PA 20-SSM:	
	VdS 0786-CPD- 21184		VdS 0786-CPD- 21223	0786-CPD- 21224
				PA 10/ PA 20
	Опции			-SSM (24 В DC)
	Рабочее напряжение		24 - 48 В DC	110 – 240 В AC
	Диапазон рабочего напряжения согласно EN54-3		18 – 60 В Опция: -SSM (18 – 30 В)	95 – 265 В AC
	Тональность		Согласно Директиве ЕС по строительным изделиям (89/106/EWG)	
	2 15 60 104 131 146		1200-500 Гц (звук пилы DIN/PFEER P.T.A.P.) 500-1200 Гц (с повышением тональности) 825 Гц (постоянная тональность) 660 Гц (с прерыванием) 800 / 1000 Гц (меняющаяся тональность) 544 / 440 Гц (NF S 32-001)	
	Область использования сигнализации		EN54-3: см. документ 30305-005-1 (PA 10) и 30305-006-1 (PA 20)	
	Класс защиты окружающей среды		Б	
Испытания проводились с использованием мембранного ниппеля (в комплекте) и внешних крепежных отверстий.				
Союз страховщиков	PA10 / PA 20, 110 – 230 AC:	PA10/ PA 20, 24 - 48 DC:	PA10-SSM, PA 20-SSM:	
	G212116	G212191	G212192	
см. Директиву ЕС по строительным изделиям (305/2011/CE)				
GL	61062-13 HH Класс безопасности по отношению к окружающей среде С, Н, EMC1			
MED	61739-14 HH			
UL, cUL	UCST, UCST7, ULSZ, ULSZ7, UEES, UEES7 (Дополнительную информацию см. на стр. 7)			

Ввод в эксплуатацию

Указания по технике безопасности:

- Подключение электрооборудования разрешается выполнять только уполномоченным сотрудникам в соответствии с предписаниями действующего законодательства.
- Осторожно: высокое напряжение.
- Во время монтажных работ питание должно быть отключено от устройства.
- Перед вводом в эксплуатацию следует проверить соответствие напряжения данным, указанным на заводской табличке. При подключении неверного напряжения оборудование может быть повреждено или выведено из строя.
- Во время монтажа необходимо предусмотреть меры, чтобы проводка не могла быть вытянута или перекручена. Следует принять во внимание, что данные устройства не являются переносными.
- ВНИМАНИЕ! При монтаже проводка не должна касаться острых краёв, углов и внутренних компонентов.
- Отверстие рупора не должно быть направлено вверх, особенно при использовании вне помещения или в запылённой среде.
- Надлежащее функционирование устройства гарантируется только в том случае, если верхняя и нижняя части смонтированы правильно.

Комбинированные светозвуковые устройства (PA X 10-10; PA X 10-15; PA X 20-10; PA X 20-15):

- Чтобы исключить отрицательное влияние на зрение, не рекомендуется долго смотреть на включенную проблесковую лампу.

Открытие корпуса:



Закрывание корпуса

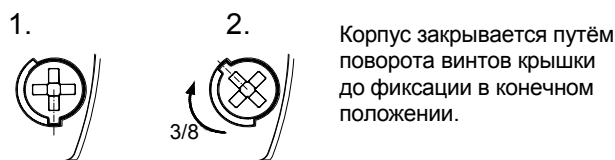

Устройство поставляется в открытом состоянии.

В качестве аксессуаров предлагаются пломбирочные пробки.

Кабельный ввод

Для сохранения имеющегося класса защиты в предусмотренные отверстия должны быть установлены кабельные вводы класса IP 66. Поставляемый мембранный ниппель можно заменить резьбовой втулкой или штекерным соединением M12 с фланцем M20.

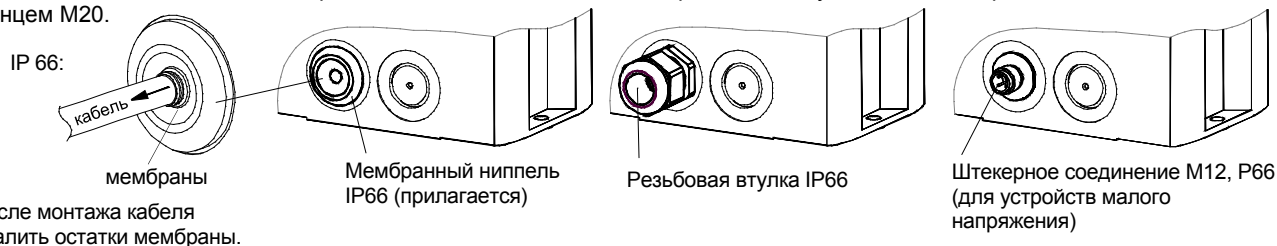

Клеммная колодка в нижней части:

Подключение питания и выбор тональности посредством внешней настройки (С1 и С2)

Подключение рабочего напряжения для звукового оповещения:

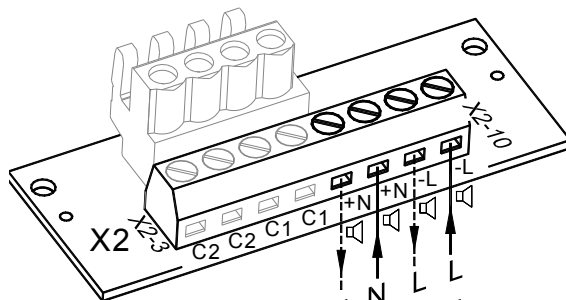

Подключение рабочего напряжения

AC: N L
DC: + -

Подключение рабочего напряжения для звукового и светового оповещения:

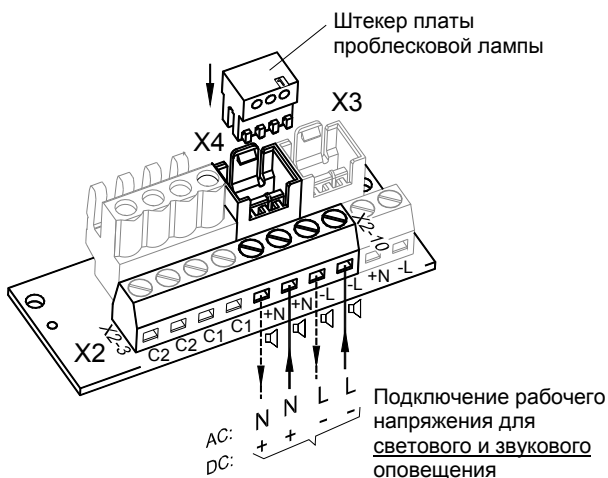

Подключение рабочего напряжения для светового и звукового оповещения

Общее подключение звуковой и световой сигнализации (вид поставляемого изделия)

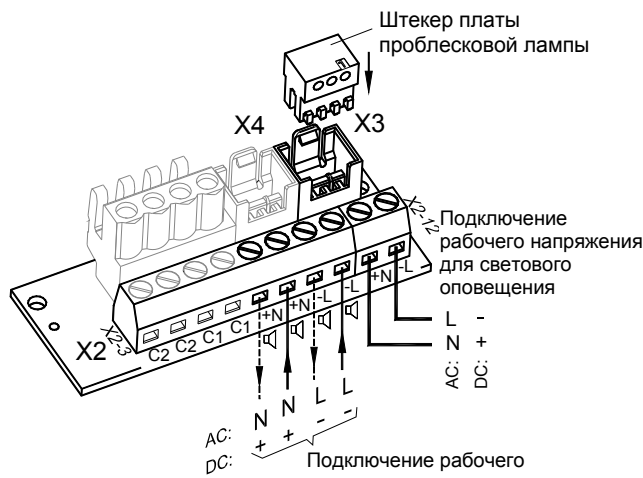

Подключение рабочего напряжения для звукового оповещения сигнализации

Раздельное подключение звукового и светового оповещения

Тональность можно выбрать с помощью переключателя S3 (задающая сигнал плата в верхней части). Описание возможных тональностей см. в таблице в приложении.

После подключения питания включается звук выбранной тональности.

Клеммная колодка (в верхней части устройства):

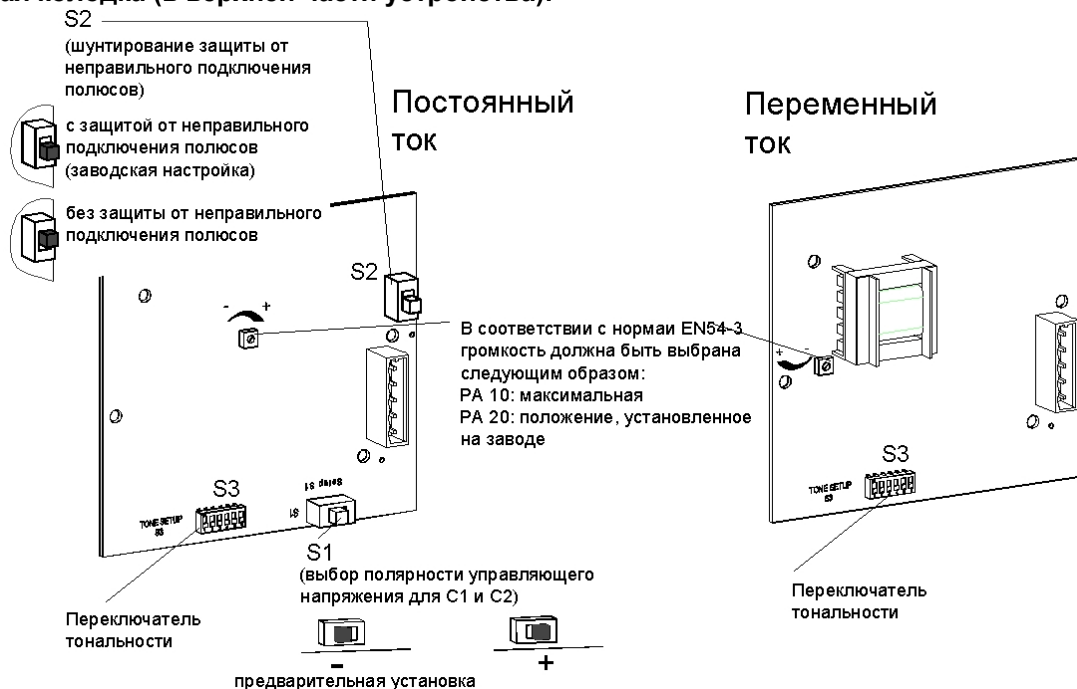

Изменение тональности посредством внешней настройки

Для случаев, когда требуется более одной звуковой тональности, посредством электрической настройки можно выбрать до трёх дополнительных.

Прежде всего, устанавливается основная тональность (♯, см. таблицу в приложении) с помощью переключателя S3 на задающей сигнал плате. Дополнительную тональность (C1, C2, C1+C2) см. в таблице «Выбор тональности» в приложении.

Выбор тональности через вход управления (TAS)

Версия, работающая от постоянного тока:

При правильном подключении полюсов выбор тональности осуществляется через входы C1 и C2 клеммной колодки. При этом должны быть подключены как входы управления, так и напряжение питания. Переключателем S2 на задающей пластине включена защита от неправильного подключения полюсов (with rectifier).

С помощью переключателя S1 на задающей сигнал пластине осуществляется выбор управляющего напряжения («+» или «-»).

«+»: положительная настройка

«-»: отрицательная настройка (заводская)

Внимание: Если управляющее напряжение превосходит напряжение питания или напряжение питания отсутствует, ток питания подаётся через входы управления. При этом нагрузка не должна превышать допустимую.

Версия, работающая от переменного тока:

В версии, работающей от переменного тока, выбор тональности осуществляется посредством подключения фазы «L» напряжения питания к входу управления C1 или C2. При этом должны быть подключены как входы управления, так и линия питания.

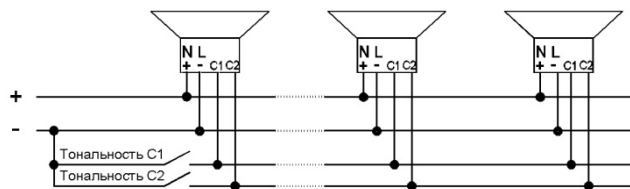
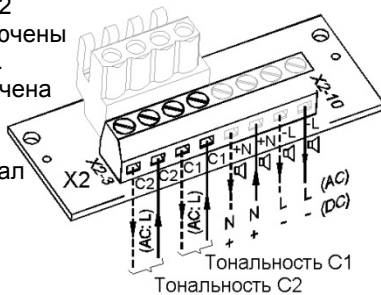

Пример для настройки «-»

Выбор тональности путём подключения питания к входу управления TAV – для всех версий постоянного тока

Рабочее напряжение можно подключить к звуковой сигнализации через входы управления C1 или C2 на клеммной колодке. В этом случае входы служат как для выбора тональности, так и подачи питания.

Отрицательный полюс звуковой сигнализации должен быть подключен. Основная тональность устанавливается путём подключения положительного контакта к положительному полюсу присоединительной планки (♯); при подключении входов C1 и C2 настраивается соответствующая тональность.

При одновременном подключении положительного контакта к C1 и C2 выбирается тональность «C1+C2».

Переключатель S1 на задающей сигнал пластине должен находиться в положении «+».

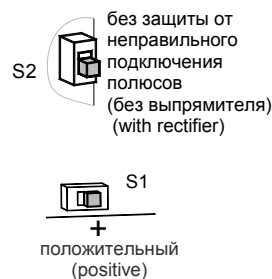
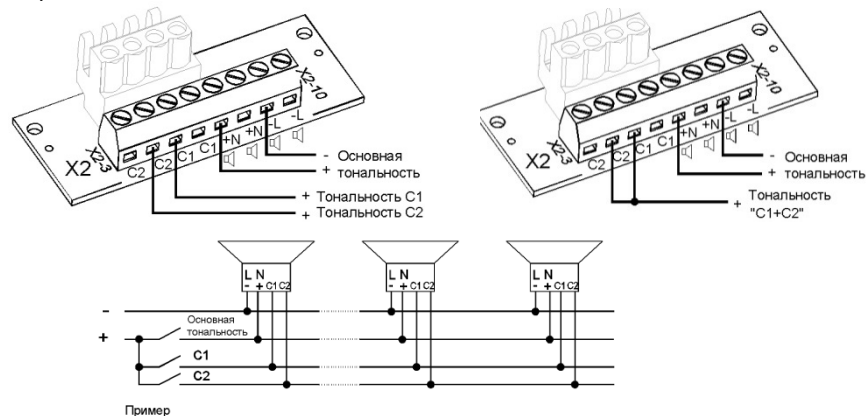

Выбор тональности путём изменения полярности TAR – для всех версий постоянного тока (кроме опции SSM)





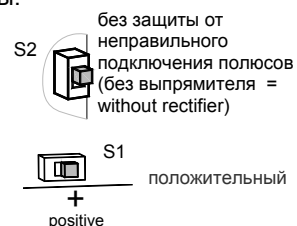
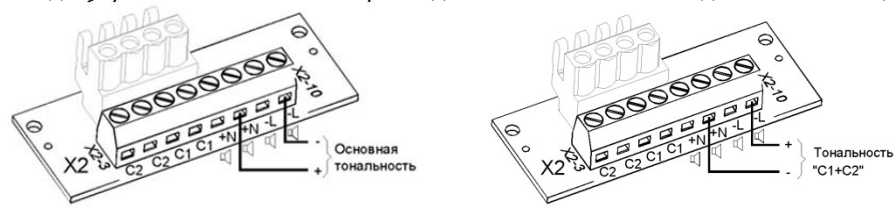

Если переключателем S2 на задающей пластине не выбрана защита от неправильного подключения полюсов (без выпрямителя = without rectifier), путём изменения полярности рабочего напряжения помимо основной тональности (♯) можно выбрать тональность «C1+C2». Переключатель S1 должен быть в положении «+».

Входы управления C1 и C2 на присоединительной планке не должны быть подключены.



Опция SSM (Модуль плавного пуска) (только 24 В пост. тока):

- Максимальный пусковой ток

PA 10-SSM:	 : макс. 2,1 А	
PA 20-SSM:	 : макс. 4,5 А	
PA X 10-xx-SSM:	 : макс. 2,1 А	 : макс. 4,5 А
PA X 20-xx-SSM:	 : макс. 4,5 А	 : макс. 4,5 А

- К устройству подводится напряжение питания, превышающее 7 В
 - Резистор контроля кабеля

Диапазон рабочего напряжения: 18 – 30 В пост. тока

Резистор контроля цепи:

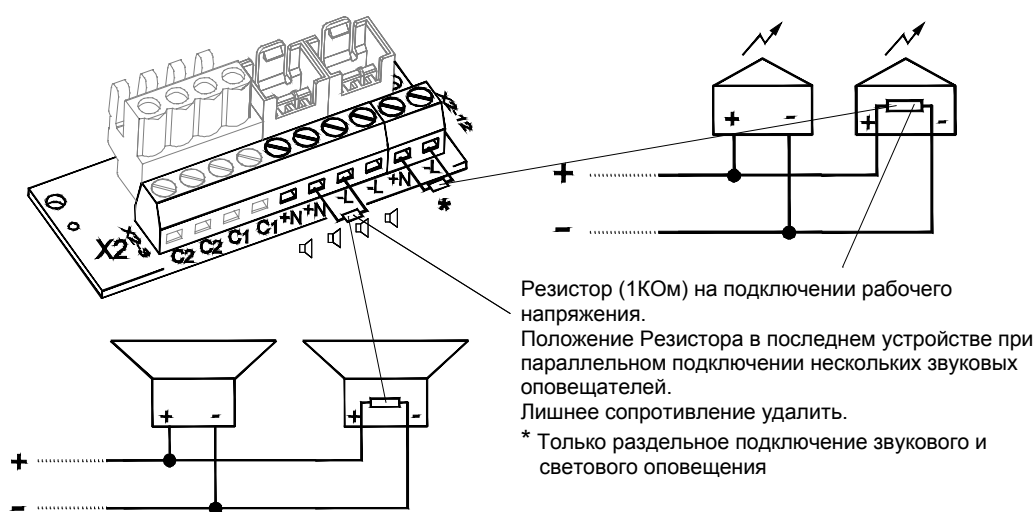

Техническое обслуживание и поддержание в исправном состоянии

Для данного устройства специальное техническое обслуживание не требуется. Очистка наружных поверхностей осуществляется с помощью слабого мыльного раствора без использования растворителей. Разрешается использовать *устройство* только в неповреждённом состоянии, согласно техническим характеристикам. При изменении конструкции, модификации оборудования, его неправильном использовании и использовании не по назначению, а также при несоблюдении указаний данного руководства гарантия теряет свою силу. Разрешается использовать только оригинальные запасные части. Ремонт производится только на предприятии-изготовителе.

PA 10/20

PA X 10-10/ PA X 10-15

PA X 20-10/ PA X 20-15

Manuale d'uso e installazione

Dimensioni

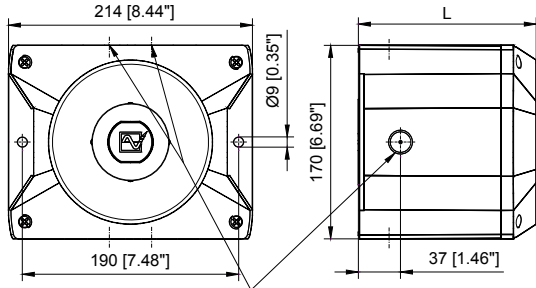

Contenuto della confezione:

- 1x dispositivo di allarme
- 1x nipplo a membrana M20
- 1x manuale d'uso
- 1x resistenza (solo per la versione SSM - modulo soft start)

	L
PA (X) 10..	156,2 mm [6,15"]
PA (X) 20..	181,2 mm [7,13"]

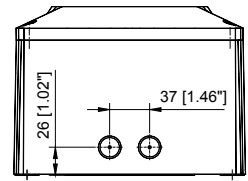

Apertura M20 predisposta

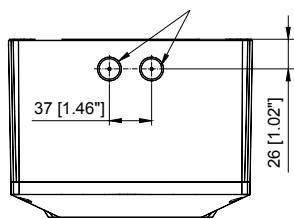

PA 10/ PA 20

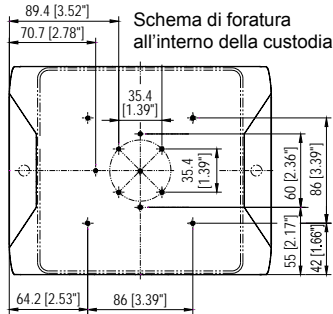

Schema di foratura all'interno della custodia

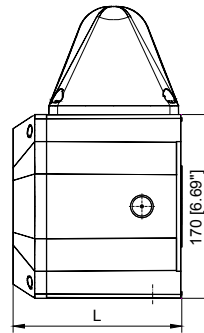

**PA X 10-10/ PA X 10-15
PA X 20-10/ PA X 20-15**

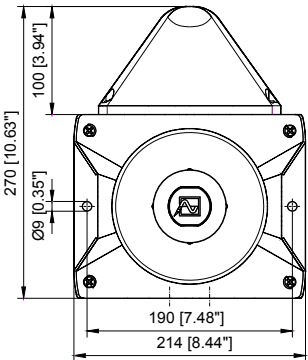

Specifiche tecniche

	PA 10	PA 20	PA X 10-10	PA X 10-15	PA X 20-10	PA X 20-15
Intensità sonora nom.	110dB (A) 1m	120dB (A) 1m	110dB (A) 1m		120dB (A) 1m	
Regolazione volume	-10dB	-9dB	-10dB		-9dB	
Suoni	80					
Energia flash	-		10J	15J	10J	15J
Frequenza di flash	1Hz					
Tensione nominale (per le limitazioni consultare le omologazioni)	24 V CC oder 12-48V CC 24V CA	110 - 240 V CA 50/60 Hz 24 V CC oder 12-48V CC 24V CA	110 - 240 V CA 50/60 Hz 12V CC 24V CC 48V CC 24V CA	115V CA 230V CA 12V CC 24V CC 48V CC 24V CA	115V CA 230V CA 12V CC 24V CC 48V CC 24V CA	115V CA 230V CA 12V CC 24V CC 48V CC 24V CA
Intervallo di tensione	10 - 60 V 20 - 30V	95 - 265 V 10 - 60 V 20 - 30V	95 - 265V 10,5 - 15V 18V - 30V 40V - 60V 20 - 30V	95V - 127V 195V - 253V 10,5 - 15 V 18V - 30V 40V - 60V 20 - 30V	95V - 127V 195V - 253V 10,5 - 15 V 18V - 30V 40V - 60V 20 - 30V	95V - 127V 195V - 253V 10,5 - 15 V 18V - 30V 40V - 60V 20 - 30V
Corrente assorbita segnalatore acustico (max) in [mA]	24V: 360 12-48V: 485 850	140	24V: 800 880	1600	330	490
Corrente assorbita luce flash (max) in [mA]	-	-	1400	680	300	1400
Potenza assorbita	24V: 8,5 W 12-48V: 9W 17,5 VA	15,5 VA	22 W 22 W 32 W 54,5 VA	300	150	29 W 27,5 W 32,5 W 57 VA
Fattore di servizio	100%					
Morsetti	0,14 - 2,5mm ² cavo flessibile / AWG24 - AWG 14 (trefolo)					
Grado di protezione	IP66 (EN60529), Tipo 4 & 4x					
Resistenza agli urti	IK08 (EN50102)					
Classe di protezione	II					
Temp. d'esercizio	-40°C...+55°C					
Temp. di stoccaggio	-40°C...+70°C					
Umidità dell'aria, max.	90%					
Ingresso cavi	7x M20 predisposti			5x M20 predisposti		
Intervallo di serraggio passacavo	7 - 13 mm In caso di utilizzo di cavi di diametro < 7 mm bisogna prevedere un raccordo pressacavo con un grado di protezione adeguato					
Materiale custodia	Miscela PC/ABS					
Materiale calotta	PC					
Posizione di montaggio	A piacere					
Opzioni	-SSM, (vedere pagina 26)					
Accessori	Tappi sigillanti (n° art. 28300000002)					
Colori calotta	- Trasparente neutro, bianco, giallo, arancione, rosso, verde, blu					

Omologazioni

Omologazioni (solo per dispositivi con marcatura)				
Regolamento sui prodotti da costruzione (305/2011/CEE)	PA10/ PA 20, 110-230V CA:	PA10/ PA 20, 24-48V DC:	PA10-SSM, PA 20-SSM:	
	VdS 0786-CPD- 21184	VdS 0786-CPD- 21223	0786-CPD- 21224	
	PA 10/ PA 20			
	-SSM (24V CC)			
	Opzioni			
	Tensione nominale	24 -48 V CC	110V – 240V CA	
	Intervallo di tensione secondo EN54-3	18V – 60V Option: -SSM: 18V – 30V	95V – 265V CA	
	Suono	In conformità con la Direttiva sui prodotti da costruzione (89/106/CEE) 1200Hz-500Hz (dente di sega) DIN/PFEER P.T.A.P. 500Hz-1200Hz (suono ascendente) 825Hz (suono continuo) 660Hz (suono intermittente) 800Hz/ 1000Hz (suono alternato) 544Hz/ 440Hz (NF S 32-001)		
	Volume di copertura	EN54-3: vedere documento 30305-005-1 (PA 10) und 30306-005-1 (PA 20)		
	Classe di protezione ambientale	Tipo B		
La verifica è stata effettuata utilizzando il nipplo a membrana fornito e i fori di fissaggio esterni.				
VdS	PA10/ PA 20, 110 – 230V CA:	PA10/ PA 20, 24 - 48V DC:	PA10-SSM, PA 20-SSM:	
	G212116	G212191	G212192	
	Per i dati vedere il regolamento sui prodotti da costruzione (305/2011/CEE)			
GL	61062-13 HH Categoria ambientale C, H, EMC1			
MED	61739-14 HH			
UL, cUL	UCST, UCST7, ULSZ, ULSZ7, UEES, UEES7 (weiterführende Informationen siehe Seite 7)			

Messa in funzione

Precauzioni da adottare:

- Il collegamento elettrico deve essere realizzato esclusivamente a opera di personale autorizzato e in conformità alle prescrizioni attualmente in vigore.
- Pericolo: presenza di alta tensione.
- Prima dell'apertura accertarsi che l'apparecchio non sia sotto tensione.
- Prima della messa in funzione verificare la tensione di alimentazione riportata sulla targhetta identificativa. Una tensione d'esercizio errata può provocare danni al dispositivo o la distruzione dello stesso.
- In fase di installazione controllare il cavo di collegamento al fine di prevenirne la trazione e la torsione. Attenzione: questi segnalatori non sono progettati per un uso mobile.
- **AVVERTENZA:** in fase di installazione mantenere la cavetteria a distanza da componenti interni, angoli e spigoli vivi.
- L'apertura della tromba acustica non deve essere rivolta verso l'alto, in particolare in caso di impiego all'esterno oppure in ambienti con forte presenza di polvere.
- Il funzionamento dell'apparecchio è garantito solo se la sezione superiore e la sezione inferiore sono collegate correttamente.

In caso di utilizzo della combinazione con la luce (PA X 10-10; PA X 10-15; PA X 20-10; PA X 20-15):

- Per prevenire danni alla vista, non fissare la luce accesa.

Apertura della custodia:

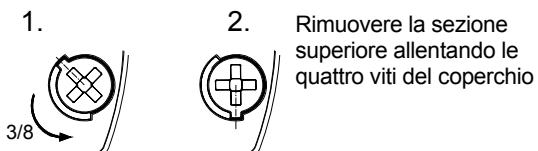

Chiusura della custodia:

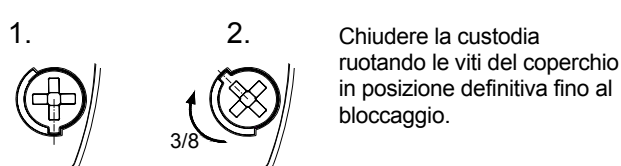

L'apparecchio viene fornito non chiuso.

Come accessori sono disponibili tappi sigillanti per le viti della custodia.

Passaggi per cavi

Per garantire il grado di protezione indicato occorre montare passaggi per cavi con un grado di protezione IP 66 nelle aperture appositamente previste. Il nipplo a membrana fornito può essere sostituito da un raccordo pressacavo o da un connettore M12 con flangia M20:

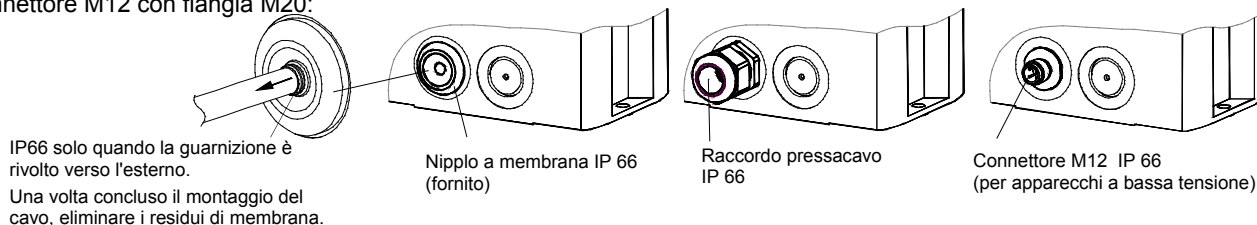

IP66 solo quando la guarnizione è rivolto verso l'esterno.

Una volta concluso il montaggio del cavo, eliminare i residui di membrana.

Nipplo a membrana IP 66 (fornito)

Raccordo pressacavo IP 66

Connettore M12 IP 66 (per apparecchi a bassa tensione)

**Scheda di collegamento nella sezione inferiore:
Collegamento elettrico e selezione dei suoni tramite dispositivo di comando esterno C1 e C2**

Collegamento della tensione d'esercizio – Segnalatore acustico

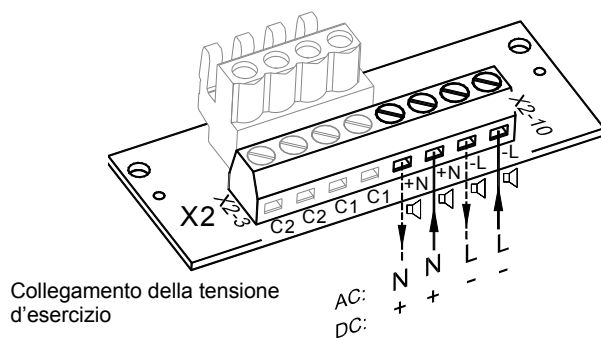

Collegamento della tensione d'esercizio – Combinazione segnalatore acustico – luci flash:

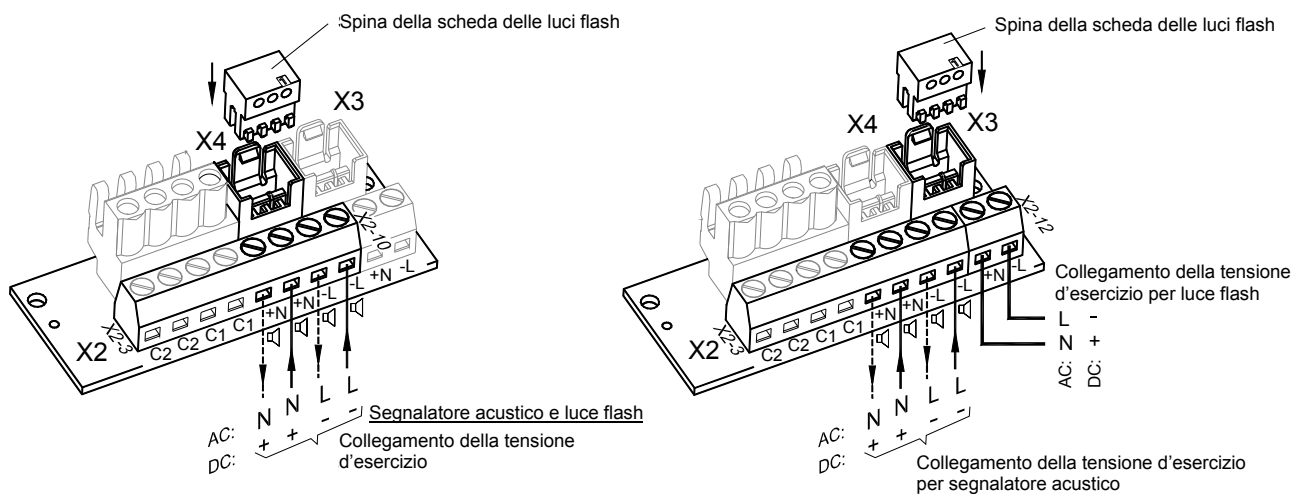

Collegamento comune di luce flash e segnalatore acustico (stato alla consegna)

Collegamento separato di luce flash e segnalatore acustico

Il suono desiderato è selezionabile grazie al selettore S3 (sulla scheda driver nella sezione superiore). I suoni disponibili sono descritti nella relativa tabella in appendice. Applicare la tensione di alimentazione per generare il suono.

Scheda driver del segnalatore acustico (nella sezione superiore):

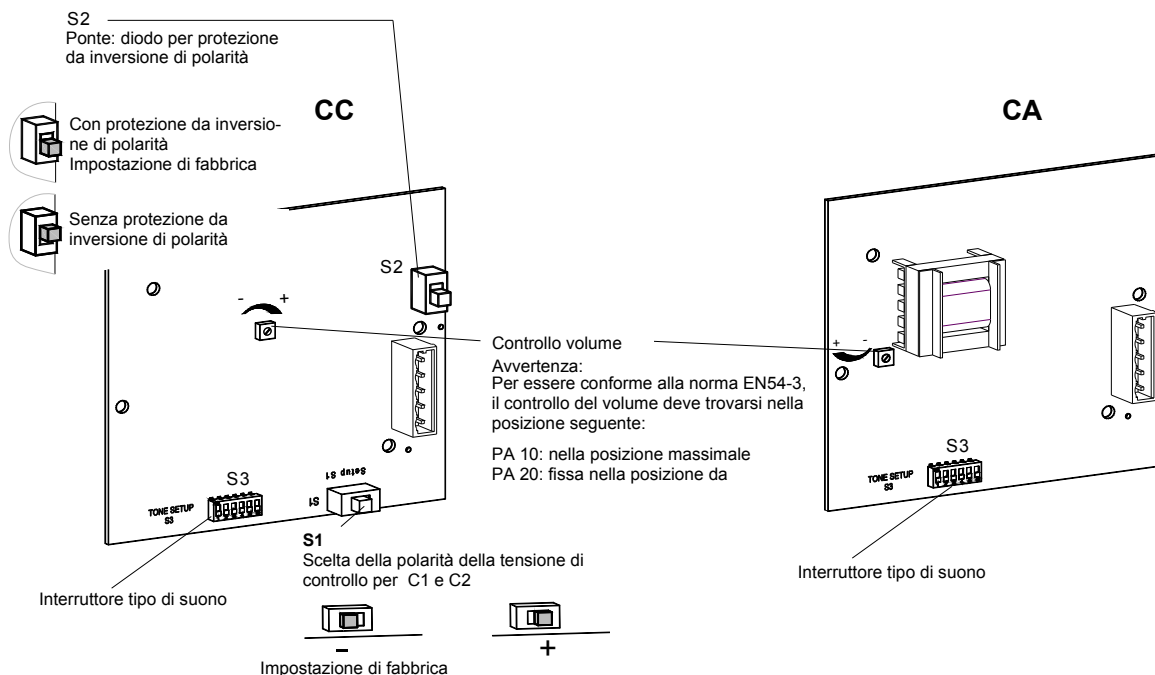

Modifica dei suoni tramite dispositivo di comando esterno

Per applicazioni che richiedono più suoni, i dispositivi di comando elettrici descritti di seguito consentono di aggiungerne fino ad altri tre, oltre a quello di base.

In linea di massima, il selettore S3 nella scheda driver consente di impostare solo il suono base desiderato (♫, vedere relativa tabella in appendice). I corrispondenti suoni supplementari (C1, C2, C1+C2) sono desumibili dalla tabella "Comando suoni" in appendice.

Scelta del livello dei suoni mediante ingresso di controllo (TAS)

CC-Version:

Quando la polarità è corretta, la selezione del suono avviene tramite gli ingressi di controllo C1 e C2 nella scheda di collegamento. La tensione di alimentazione deve sempre essere applicata insieme ai due ingressi di controllo. Il selettore S2 nella scheda di collegamento è nella posizione con protezione da inversione di polarità. La polarità della tensione di comando viene scelta ("+" tramite il selettore S1 sulla scheda driver ("+" o "-")

"+": comando positivo

"-": comando negativo (impostazione di fabbrica)

Attenzione: Se la tensione di comando è maggiore della tensione di alimentazione o non viene applicata tensione di alimentazione, la corrente d'esercizio viene alimentata tramite gli ingressi di controllo. Occorre quindi garantire una portata adeguata.

Versione CA:

Nella versione CA, il suono viene scelto collegando la fase "L" della tensione di alimentazione agli ingressi di controllo C1 o C2. La tensione di alimentazione deve sempre essere applicata insieme ai due ingressi di controllo (qui a sx esempio per un comando "-").

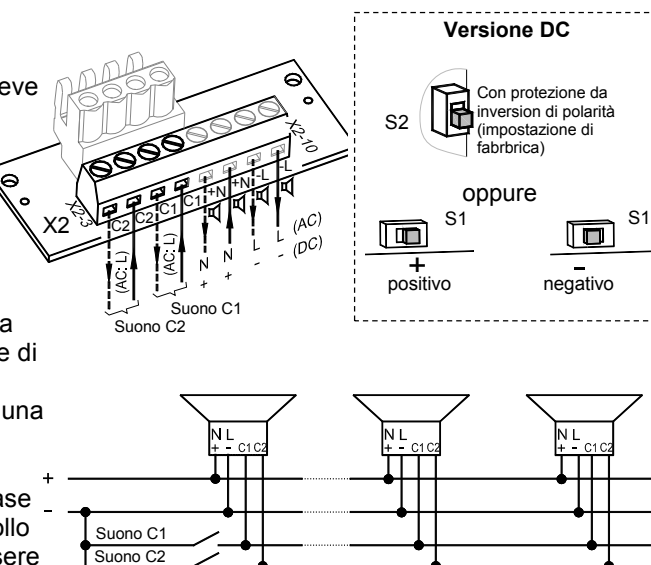

Esempio per comando DC "-"

Scelta del livello dei suoni mediante alimentazione tramite ingresso di controllo (TAV) – per tutte le versioni CC

Il segnalatore acustico può essere alimentato con tensione d'esercizio tramite gli ingressi di controllo C1 e C2 sulla scheda di collegamento. Alimentazione e scelta del livello dei suoni avvengono quindi contemporaneamente.

Il polo negativo del segnalatore acustico deve essere collegato. Il collegamento della tensione positiva al polo positivo della scheda di collegamento genera il suono base (♫); il collegamento agli ingressi C1 e C2 consente di scegliere i corrispondenti livelli dei suoni.

Il collegamento simultaneo della tensione positiva agli ingressi C1 e C2 consente di scegliere il livello "C1+C2". Il selettore S1 sulla scheda driver deve essere su "+".

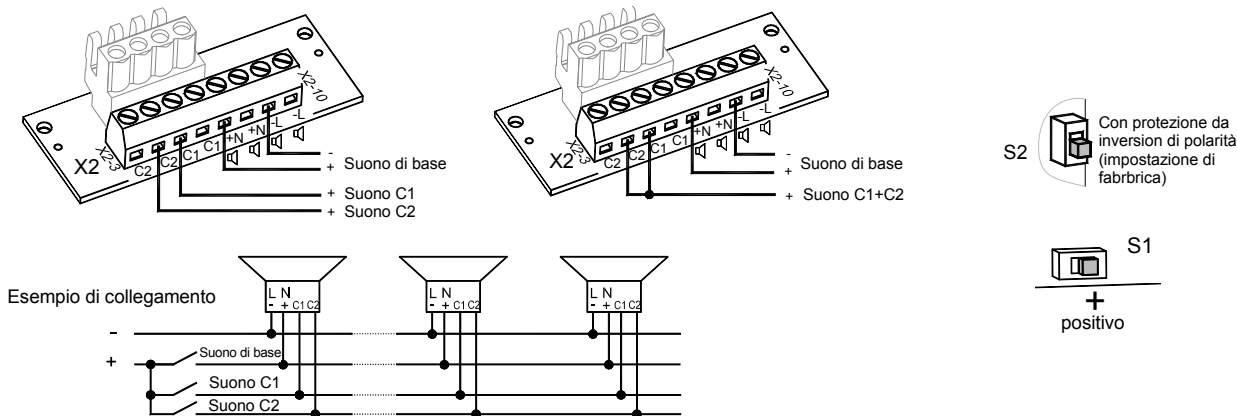

Scelta del livello dei suoni tramite inversione di polarità (TAR) - per tutte le versioni CC (tranne l'opzione SSM)





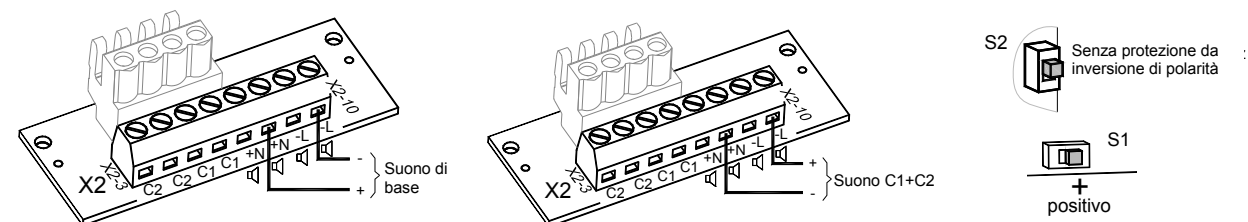

Se il selettore S2 sulla scheda driver è in posizione con protezione da inversione di polarità, l'inversione di polarità della tensione d'esercizio consente di aggiungere al suono base (♫) il suono "C1+C2". Il selettore S1 deve essere impostato su "+".

Gli ingressi di controllo C1 e C2 non devono essere cablati sulla scheda di collegamento.



Opzione –SSM (modulo soft start, solo 24V CC):

- Limitazione della corrente allo spunto a:

PA 10-SSM:	 : max. 2,1 A	
PA 20-SSM:	 : max. 4,5 A	
PA X 10-xx-SSM:	 : max. 2,1 A	 : max. 4,5 A
PA X 20-xx-SSM:	 : max. 4,5 A	 : max. 4,5 A

- Commutazione della tensione d'esercizio al dispositivo solo a partire da > 7V
 - Resistenza per il monitoraggio cavi collegata

Intervallo della tensione d'esercizio: 18V – 30V CC

Resistenza per il monitoraggio cavi:

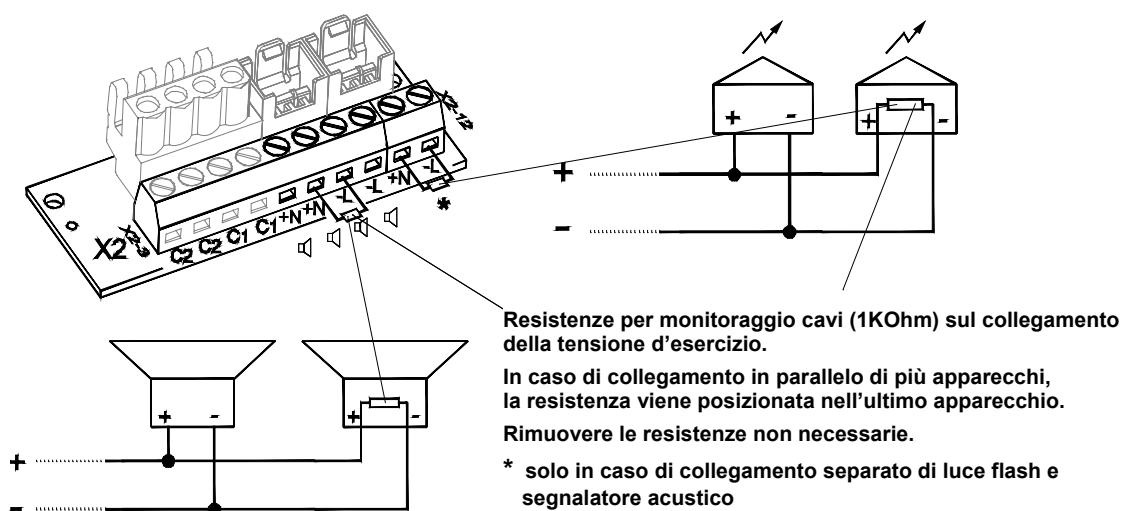

Manutenzione, assistenza, riparazione





L'apparecchio non necessita di una particolare manutenzione. Per la pulizia esterna utilizzare un detergente neutro senza solventi.





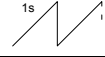

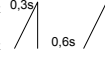
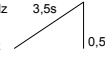
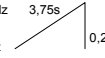
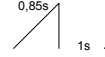
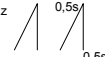
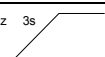
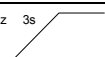
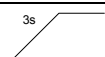
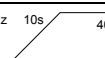
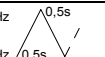
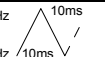
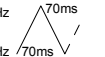
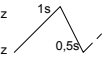
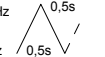

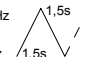
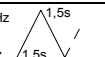
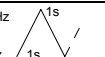
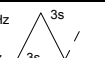
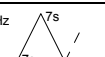
Il segnalatore acustico può essere utilizzato solo se perfettamente integro e nel rispetto dei dati tecnici specificati. Eventuali modifiche e alterazioni così come l'impiego errato o non consentito e il mancato rispetto delle istruzioni riportate nel presente manuale comportano l'esclusione della garanzia.

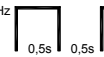
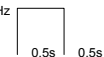
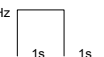
Per eventuali sostituzioni di componenti utilizzare solo pezzi di ricambio originali. Gli interventi di riparazione vengono effettuati in linea di massima presso l'officina del costruttore.

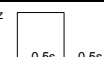
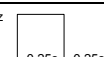
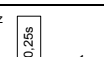
Anhang/ Appendix/ Annexe/ Appendice
„Tonartentabelle“ und „Ansteuerung der Töne“
„Tone table“ and „Selection of the tones“
«Tableau des sons» et «Activation des sons»

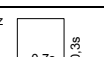
Tonartentabelle/ Tone table/ Tableau de sons/ Tabella suoni

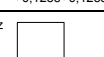
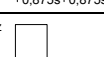
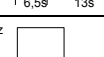
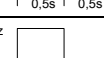
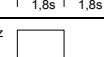
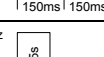
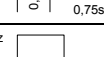
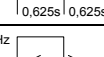
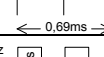
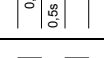
Grund-Ton-Nr. (♫)	Beschreibung/ Description/ Descrizione		
1	Kein Ton/ Silence/ Pas de son/ Nessun suono		
2*	Saw tooth, Germany DIN 33404-3 (emergency signal), PFEER PTAP	1200Hz 500Hz	1s  EN54-3
9	Slow whoop, fire alarm, UK BS5839-1	970Hz 800Hz	1s 
11	Whoop (fast)	970Hz 800Hz	20ms 
13	Whoop	900Hz 700Hz	0,3s 0,6s 
15	Slow whoop, evacuation, Netherlands NEN 2575	1200Hz 500Hz	3,5s 0,5s  EN54-3
16	Slow whoop, evacuation Australia AS2220	1200Hz 500Hz	3,75s 0,25s 
18	Slow whoop, NFPA	775Hz 422Hz	0,85s 1s 
22	Whoop, Australia AS1670, ISO8201	1200Hz 500Hz	0,5s 0,5s 1,5s 
23	Siren	2400Hz 500Hz	3s const. 
24	Siren	1200Hz 300Hz	3s const. 
25	Siren	800Hz 300Hz	3s const. 
26	Industrial alarm (Germany)	1000Hz 150Hz	10s 40s 10s 
27	Sweeping	2900Hz 2400Hz	0,5s 0,5s 
29	Sweeping (fast)	2900Hz 2400Hz	10ms 10ms 
30	Sweeping	2900Hz 2400Hz	70ms 70ms 
31	Sweeping, France NF C 48-265	1600Hz 1400Hz	1s 0,5s 
33	Sweeping, UK BS5839-1 (medium sweep)	1000Hz 800Hz	0,5s 0,5s 
34	Sweeping (fast)	1000Hz 800Hz	10ms 10ms 
35	Sweeping, UK BS5839-1 (fast sweep)	1000Hz 800Hz	70ms 70ms 
36	Sweeping	1500Hz 700Hz	1,5s 1,5s 
43	Sweeping	1200Hz 500Hz	1,5s 1,5s 
44	Sweeping, IMO 3d, Germany KTA3901 evacuation	1200Hz 500Hz	1s 1s 
45	Sweeping	1200Hz 500Hz	3s 3s 
46	Sweeping, Finland General Alarm	1500Hz 500Hz	7s 7s 
52	Continuous	2400Hz	— —
53	Continuous	2000Hz	— —

(♫)	Beschreibung/ Description/ Descrizione	
54	Continuous, Finland All Clear	1500Hz — —
55	Continuous	1200Hz — —
56	Continuous, PFEER (Gasalarm)	1000Hz — —
57	Continuous, UK BS5839-1	950Hz — —
59	Continuous	880Hz — —
60	Continuous	825Hz — — EN54-3
61	Continuous	800Hz — —
63	Continuous	725Hz — —
65	Continuous, Sweden SS031711 (All Clear)	660Hz — —
66	Continuous	554Hz — —
67	Continuous, Germany KTA3901 (All Clear)	500Hz — —
68	Continuous	470Hz — —
69	Continuous	440Hz — —
71	Continuous	340Hz — —
77	Intermittent	2400Hz 
82	Intermittent, PFEER (General Alarm), UK BS5839-1 (Backup Alarm)	1000Hz 
83	Intermittent, PFEER (General Alarm)	1000Hz 
88	Intermittent	950Hz 
90	Intermittent	825Hz 
91	Intermittent	800Hz 
92	Intermittent	800Hz 
93	Intermittent (fast), electromechanical horn	800Hz 
97	Intermittent	725Hz 
98	Intermittent, Sweden SS 031711 (Imminent Danger)	700Hz 
100	Intermittent, Industrial Alarm (Germany)	680Hz 
101	Intermittent, Sweden SS031711 (Important Message (Pre Mess))	660Hz 
102	Intermittent, Sweden SS031711 (Local Warning)	660Hz 
103	Intermittent, Sweden SS031711 (Air Raid)	660Hz 
104	Intermittent, Sweden SS031711 (Imminent Danger)	660Hz  EN54-3
107	Intermittent, Germany KTA3901 (evacuation)	500Hz 
109	Intermittent, Australia AS2220, AS1610, AS1670	420Hz 
110	Intermittent (fast variable), Bell	1450Hz 
111	Intermittent, ISO8201 (emergency evacuation signal), USA (evacuation)	470Hz 
112	Intermittent, ISO8201 (emergency evacuation signal)	950Hz 
113	Intermittent, ISO8201 (emergency evacuation signal) treble tone	2850Hz 

Grund-Ton-Nr. (♫)	Beschreibung/ Description/ Descrizione	
115	Intermittent, IMO (Telephone Call)	950Hz
116	Intermittent, IMO (abandon ship)	950Hz
117	Intermittent, IMO SOLAS III/50 + SOLAS III/6.4 (General Alarm)	825Hz
122	Alternating	2900Hz 2400Hz
123	Alternating	2900Hz 2400Hz
124	Alternating, Singapore	2000Hz 1000Hz
125	Alternating	1400Hz 1200Hz
128	Alternating	1025Hz 825Hz
130	Alternating, UK BS5839-1 (Fire Alarm)	1000Hz 800Hz
131	Alternating, UK BS5839-1 (Fire Alarm, Level crossing)	1000Hz 800Hz
135	Alternating, UK BS5839-1 (Fire Alarm, increased urgency Level crossing)	1000Hz 800Hz
142	Alternating	900Hz 500Hz
143	Alternating, Germany Industrial Alarm	660Hz 440Hz
144	Alternating	650Hz 440Hz
146	Alternating, France NFS 32-001 (fire alarm)	554Hz 440Hz
147	Alternating, Sweden SS031711 (turn out)	554Hz 440Hz
148	Alternating, Sweden SS031711 (turn out)	554Hz 440Hz
152	Alternating-intermittent	800Hz 650Hz

Tonartenschalter/ Selector –switch (Einstellung des Grundtones/ Adjusting the base tone)							External Tone Control		
1	2	3	4	5	6	Grund-Ton No. (♫)	Tone No.	Tone No.	Tone No.
ON		ON	ON			27	123	52	92
	ON	ON	ON			29	35	52	61
ON	ON	ON	ON			30	27	52	77
				ON		31	131	52	57
ON				ON		33	30	52	35
	ON			ON		34	35	52	93
ON	ON			ON		35	27	52	110
		ON		ON		36	146	67	57
ON		ON		ON		43	131	52	91
	ON	ON		ON		45	2	57	93
ON	ON	ON		ON		52	15	65	82
			ON	ON		54	46	54	131
ON			ON	ON		55	131	52	128
	ON		ON	ON		56	82	35	33
ON	ON		ON	ON		59	143	59	101
		ON	ON	ON		60	131	52	125
ON		ON	ON	ON		65	131	52	93
	ON	ON	ON	ON		66	110	52	107
ON	ON	ON	ON	ON		69	131	52	110
				ON		71	131	52	93
ON				ON		77	61	52	122
	ON			ON		82	131	52	83
ON	ON			ON		83	56	2	82
		ON		ON		88	2	57	128
ON		ON		ON		90	131	52	125
	ON	ON		ON		91	30	52	110
ON	ON	ON		ON		92	33	52	57
			ON	ON		93	2	128	57
ON			ON	ON		97	2	63	93
	ON		ON	ON		100	131	52	125
ON	ON		ON	ON		101	98	102	65
		ON	ON	ON		103	131	65	147
ON		ON	ON	ON		104	103	65	101
	ON	ON	ON	ON		109	16	52	22
ON	ON	ON	ON	ON		110	131	61	91
				ON	ON	112	2	57	128
ON				ON	ON	113	52	123	104
	ON			ON	ON	115	117	116	44
ON	ON			ON	ON	116	117	93	125
		ON		ON	ON	117	93	116	125
ON		ON		ON	ON	123	27	52	77
	ON	ON		ON	ON	124	53	83	2
ON	ON	ON		ON	ON	130	2	107	67
			ON	ON	ON	131	2	112	57
ON			ON	ON	ON	135	16	56	109
	ON		ON	ON	ON	142	2	54	88
ON	ON		ON	ON	ON	143	59	93	33
		ON	ON	ON	ON	144	110	61	2
ON		ON	ON	ON	ON	146	31	67	57
	ON	ON	ON	ON	ON	148	131	52	92
ON	ON	ON	ON	ON	ON	152	110	61	13

Ansteuerung der Töne/ Selection of the tones/ Activation des sons/ Comando suoni:

Tonartenschalter/ Selector –switch (Einstellung des Grundtones/ Adjusting the base tone)							External Tone Control		
1	2	3	4	5	6	Grund-Ton No. (♫)	Tone No.	Tone No.	Tone No.
						1	2	88	57
ON						2*	128	112	57
	ON					2	26	100	93
ON	ON					2	61	131	112
		ON				9	57	11	82
ON		ON				15	131	52	112
	ON	ON				16	109	52	56
ON	ON	ON				18	111	57	68
			ON			22	16	109	68
ON			ON			23	131	52	112
	ON		ON			24	131	52	131
ON	ON		ON			25	131	52	92
		ON	ON			26	2	100	93

* Werkseinstellung/ Factory setting/ Réglage d'usine
Заводская настройк/ Impostazione di fabbrica

Pfannenberg

ELECTRO-TECHNOLOGY FOR INDUSTRY

Pfannenberg GmbH

Werner-Witt-Straße 1 · D- 21035 Hamburg

Tel.: +49/ (0)40/ 734 12-0 · Fax: +49/ (0)40/ 734 12-101

service@pfannenberg.com

http://www.pfannenberg.com



04/2016