

Surface-mounting distributor, plastic - VARIABOX - M

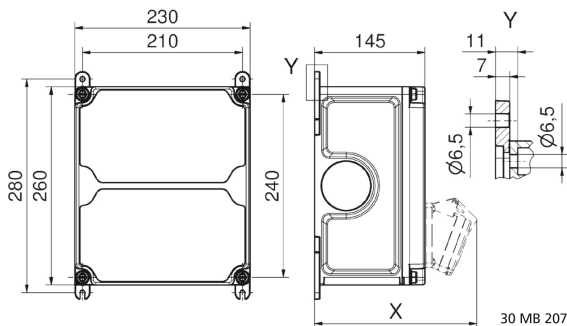

Product description	
BALS-Prd.-Nr	89031
EAN	4024941205641
Product category	VARIABOX - M
Protection degree	IP44
Colour of appliance	Housing bottom similar black RAL 9017, Housing top grey RAL 7035
Height	260mm
Width	230mm
Depth	145mm

Logistics data	
Weight/pcs	3.368 kg / Piece
Packaging	Carton
Content amount	1 ST
EAN	4024941205641
Length	300 mm
Width	270 mm
Height	255 mm
Weight	3.604 kg
Volume	20,655 ccm

Tiefenmaß/ depth X (mm)

Bezeichnung/ with	IP44	IP67
OTC-Klappe/ OTC operating window	180	180
Schutzk. Steckdose/domestic socket	162	205
CEE 16A 3p	200	200
CEE 16A 4p	204	202
CEE 16A 5p	207	205
CEE 32A 3p/4p	211	213
CEE 32A 5p	213	214
CEE 63A 3p/4p/5p	229	231