

Inhalt

1. Bestimmungsgemäße Verwendung	1
2. Lieferumfang	1
3. Abmessungen	2
4. Technische Daten	2
4.1 Allgemein	2
4.2 Elektrische Kenndaten AC	3
4.3 Elektrische Kenndaten DC.....	3
5. Zulassungen	4
6. Inbetriebnahme	5
6.1 Sicherheitshinweise	5
6.2 Elektrischer Anschluss PA 1	6
6.3 Elektrischer Anschluss PA X 1-05	6
7. Toneinstellungen (auf der Treiberplatine im Oberteil)	6
7.1 Änderung der Töne durch externe Ansteuerung	7
7.1.1 Tonstufenauswahl durch Steuereingang (TAS), DC- und AC-Versionen	7
7.1.2 Tonstufenauswahl durch Versorgung über Steuereingang (TAV) – alle DC-Versionen.....	8
7.1.3 Tonstufenauswahl durch Verpolung (TAR) – alle DC-Versionen (außer Option –SSM)	9
8. Option	9
9. Zubehör	10
10. Wartung, Service, Instandhaltung	10
11. Außerbetriebnahme, Demontage und Entsorgung	10
Anhang Tonartentabelle und Ansteuerung der Töne	
1. Bestimmungsgemäße Verwendung	

Schallgeber der PA- Serie sind für die Signalisierung von z.B. Gefahrzuständen in Industrie, Gewerbe und Gebäudebereichen bestimmt. Bei Nutzung der Schallgeber-Blitzleuchten-Kombination (PA X 1-05) besteht zusätzlich die Möglichkeit der optischen Signalisierung.

Die Schallgeber erzeugen akustische Signale in 80 verschiedenen Tonarten, die mit Hilfe eines internen Schalters ausgewählt werden können. Es besteht die Möglichkeit, durch externe Ansteuerung auf maximal 3 weitere Töne umzuschalten.

Die Geräte nur in unbeschädigtem Zustand innerhalb der spezifizierten Kenndaten betreiben. Die Funktion des Gerätes ist nur gewährleistet, wenn Ober- und Unterteil korrekt zusammengefügt ist.

Die Geräte sind für den Einsatz im Innen- und Außenbereich geeignet und nur für die ortsfeste Montage bestimmt.

2. Lieferumfang

Der Lieferumfang besteht aus:

- 1x Signalgerät
- 1x Membrannippel M20
- 1x Kurzanleitung
- 1x Widerstand (nur bei –SSM-Versionen)

3. Abmessungen

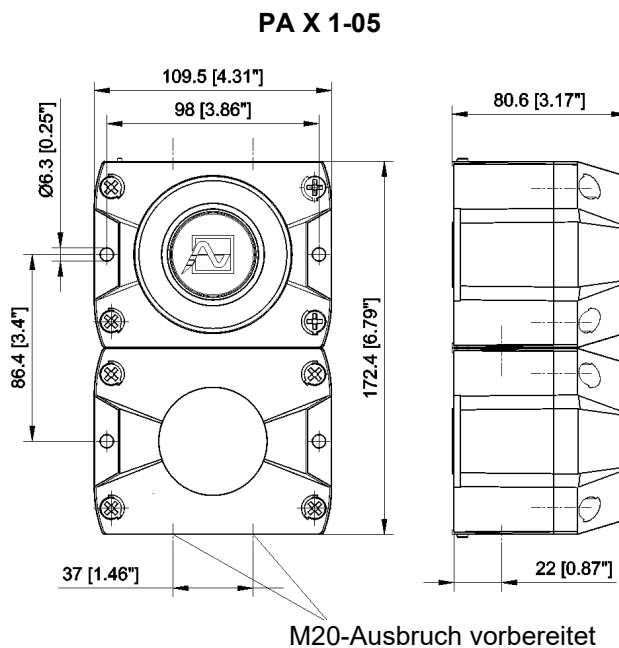
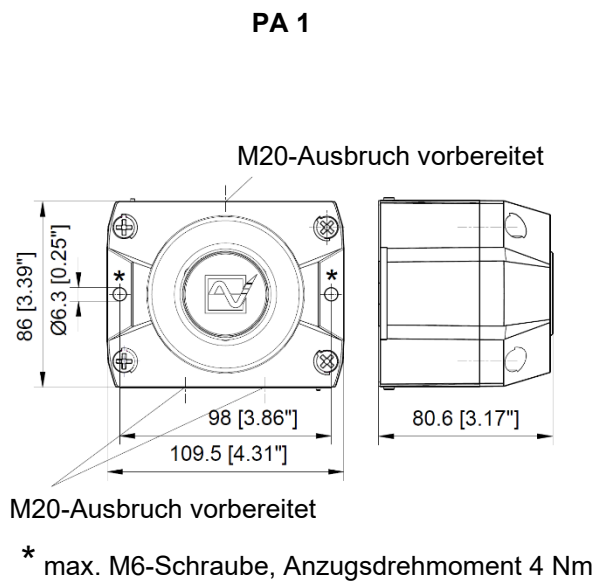

Bohrbild im Inneren des Gehäuses (PA 1)

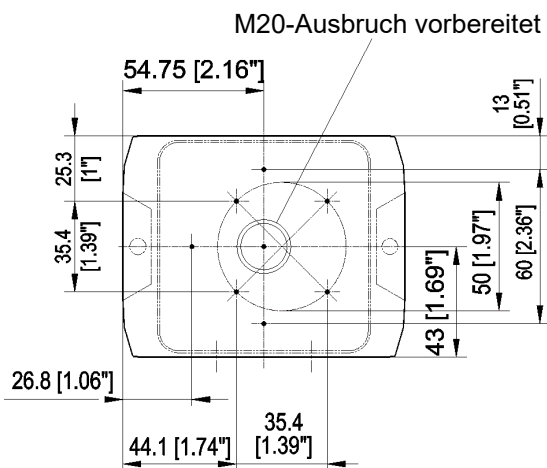

Bohrbild im Inneren des Gehäuses (PA X 1-05)

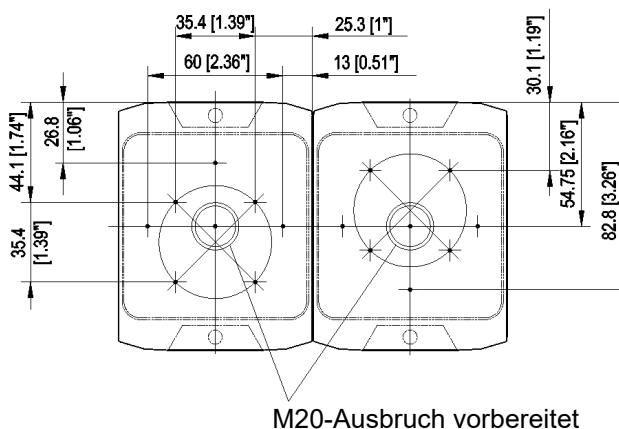

4. Technische Daten

4.1 Allgemein

	PA 1	PA X 1-05
Max. Schallpegel	105 dB (A) 1m	
Lautstärkeregelung	max. -12dB	
Töne	80	
Blitzenergie	-	5 J
Blitzfrequenz	-	1 Hz
Einschaltdauer	100%	
Anschlussklemmen	0,14 - 2,5mm ² feindrähtig / AWG24 - AWG 14	
Schutzart	IP 66 (EN 60529), Type 4 & 4x	
Schlagfestigkeit	IK08 (EN 50102)	
Schutzklasse	II	

Betriebstemperatur	-40 °C...+55 °C	
Lagertemperatur	-40 °C...+70 °C	
Max. rel. Luftfeuchte	90%	
Kabeleinführung	4x M20 vorgeprägt	5x M20 vorgeprägt
Dichtbereich der Durchführungsstülle	7 – 13 mm Bei Verwendung von Kabeldurchmessern < 7 mm eine Kabelverschraubung mit ausreichender Schutzart vorsehen	
Gehäusematerial	PC/ ABS Blend	
Haubenmaterial	PC	
Einbaulage	beliebig	
Haubenfarben	klar, weiß, gelb, orange, rot, grün, blau	

4.2 Elektrische Kenndaten AC



	PA 1				PA X 1-05		
	24 V 50/60 Hz	48 V 50/60 Hz	115 V 50/60 Hz	230 V 50/60 Hz	24 V 50/60 Hz	115 V 50/60 Hz	230 V 50/60 Hz
Bemessungsspannung (Begrenzungen siehe Zulassungen)	18 – 30 V	44 – 52 V	95 – 127 V	195 – 253 V	18 – 30V	95 – 127V	195 – 253V
Spannungsbereich	18 – 30 V	44 – 52 V	95 – 127 V	195 – 253 V	18 – 30V	95 – 127V	195 – 253V
Stromaufnahme Schallgeber (max)	150 mA	150 mA	30 mA	16 mA	150 mA	30 mA	16 mA
Stromaufnahme Blitzleuchte (max)	-	-	-	-	800 mA	120 mA	90 mA
Leistungsaufnahme	4,5 VA	9 VA	4,5 VA	4,5 VA	34,5 VA	18,5 VA	25 VA

4.3 Elektrische Kenndaten DC

	PA 1		PA X 1-05		
	24 V oder 12 – 48 V	120 V	12 V	24 V	48 V
Bemessungsspannung (Begrenzungen siehe Zulassungen)	10 – 57 V	108 – 132 V	10 – 15 V	18 – 30 V	40 – 57 V
Spannungsbereich	10 – 57 V	108 – 132 V	10 – 15 V	18 – 30 V	40 – 57 V
Stromaufnahme Schallgeber (max)	80 mA	30 mA	25 mA	70 mA	80 mA
Stromaufnahme Blitzleuchte (max)	-	-	700 mA	360 mA	170 mA
Leistungsaufnahme	12 – 48 V: 4 W 24 V: 2 W	3,6 W	8 W	11,5 W	11,5 W

5. Zulassungen





(Zulassungen gelten für gekennzeichnete Geräte)

Bauproduktverordnung (305/2011/EU)  0786 In Vorbereitung:  0843	PA 1: DoP-No.: 03CPR2013-06-07		PA X 1-05: DoP-No.: 05CPR2013-06-07		
		PA 1		PA X 1-05	
	Optionen	–SSM (24V DC)			
	Bemessungsspannung	24 – 48 V DC		24V DC	48V DC
	Spannungsbereich gemäß EN54-3, EN54-23	18 V – 57 V Option: –SSM (18 V – 30 V)		18 - 30V	40 - 57V
	Haubenfarbe Blitzleuchte	-		rot, klar	
	Ton	konform zur Bauproduktverordnung (305/2011/EU)			
	2 15 60 104 131 146	1200Hz-500Hz (Sägezahn/ Saw tooth) DIN/PFEER P.T.A.P. 500Hz-1200Hz (Ansteigender Ton/ Slow whoop) 825Hz (Dauerton/ Continuous) 660Hz (Unterbrochener Ton/ Intermittent) 800Hz/ 1000Hz (Wechselton/ Alternating) 544Hz/ 440Hz (NF S 32-001)			
	Signalisierungsbereich	EN54-3: siehe Dokument 30303-005-1		EN 54-23 Kategorie O: siehe Dokument 30303-005-1	
	Umweltschutzklasse	Typ B			
Einbaulage	beliebig		siehe Dokument 30303-005-1		
Die Prüfung erfolgte unter Verwendung des mitgelieferten Membrannippels und der äußeren Befestigungsbohrungen.					
VdS	PA 1		PA X 1-05		
	G 212115		G 212188		
Daten siehe Bauproduktverordnung (305/2011/EU)					
DNV	TAA00001R0				
MED	MEDB00002BH				
CNBOP	3558/2019		3560/2019		
UL, cUL	S7256 UCST, UCST7, ULSZ, ULSZ7, UEES, UEES7 (weiterführende Informationen siehe Seite 4 bis 5 im englischsprachigen Kapitel)				

Keine Zulassungen für PA1, 48V AC.

6. Inbetriebnahme

6.1 Sicherheitshinweise

	<p>GEFAHR - Lebensgefahr durch Stromschlag Spannungsführende Geräte und freiliegende Anschlussleitungen können Stromschläge erzeugen und schwere Unfälle verursachen.</p> <ul style="list-style-type: none"> ➤ Arbeiten an elektrischen Anschlüssen dürfen nur elektrotechnisch geschulte und autorisierte Fachkräfte durchführen. ➤ Vor der Montage alle Zuleitungen spannungsfrei schalten und gegen Wiedereinschalten sichern. Spannungsfreiheit immer sicherstellen. ➤ Entladungsphase von 5 Minuten für die elektrischen Komponenten abwarten. Erst danach Gerät öffnen. ➤ Das Anlegen der Betriebsspannung darf nur bei fest verschlossenem Gehäuse erfolgen.
	<p>WARNUNG - Gefahr durch unzulässigen Einsatz der Geräte Der nicht bestimmungsgemäße Einsatz kann zu schweren Unfällen führen.</p> <ul style="list-style-type: none"> ➤ Bei der Installation darauf achten, dass die Anschlussleitung gegen Zug und Verdrehen abgesichert ist. <p>Die Geräte sind nur für die ortsfeste Montage bestimmt. Zur Gewährleistung der dauerhaften Funktion:</p> <ul style="list-style-type: none"> ➤ in staubreicher Umgebung oder im Außenbereich den Schalltrichter nicht nach oben gerichtet montieren.
	<p>GEFAHR - Gefahr durch Beschädigung der Geräte Nichtbeachtung der Typenschild-Angaben kann zu schweren Unfällen führen.</p> <ul style="list-style-type: none"> ➤ Bei Installation und Wartung der Geräte immer die Angaben auf dem Typenschild beachten.
	<p>VORSICHT - Verletzungsgefahr durch scharfe Kanten oder erhitze Bauteile</p> <ul style="list-style-type: none"> ➤ Bei Installations-, Montage-, oder Service-/ Wartungsarbeiten Handschuhe tragen. ➤ Verdrahtung entfernt von scharfen Kanten, Ecken und internen Komponenten vornehmen.
	<p>VORSICHT - Beeinträchtigung des Hörvermögens</p> <ul style="list-style-type: none"> ➤ Um eine Beeinträchtigung des Hörvermögens zu verhindern, bei Arbeiten/ Tests eine Schallschutz-ausrüstung tragen. <p>VORSICHT – Beeinträchtigung des Sehvermögens Bei Verwendung der Schallgeber-Blitzleuchten-Kombination:</p> <ul style="list-style-type: none"> ➤ Um eine Beeinträchtigung des Sehvermögens zu verhindern, den dauernden, direkten Blick in die aktivierte Leuchte vermeiden.

Öffnen des Gehäuses

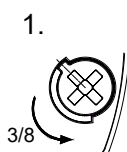

Durch Lösen der vier Deckelschrauben lässt sich das Oberteil abnehmen

Verschließen des Gehäuses

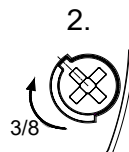

Verschließen des Gehäuses durch Drehen der Deckelschrauben in die Endstellung bis zur Verrastung.

Das Gerät wird in nicht verschlossenem Zustand ausgeliefert.
Plombierstopfen für die Gehäuseschrauben sind als Zubehör erhältlich.

Kabeldurchführungen

Der mitgelieferte Membrannippel kann durch eine Kabelverschraubung oder durch einen M12-Steckverbinder mit einem Flanschmaß von M20 ersetzt werden.

- Nur Kabelverschraubungen mit einer Schutzart von mindestens IP66 an den entsprechenden Durchbrüchen montieren.

Bei Kabeldurchmessern von <7 mm eine Kabelverschraubung mit ausreichender Schutzart verwenden.

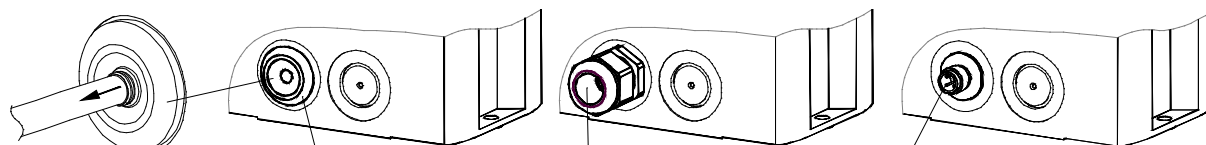

IP 66 nur bei nach außen gerichtetem Trichter der Membrane.

Membrannippel IP 66 (mitgeliefert)

Kabelverschraubung IP 66 (Option)

M12- Steckverbinder IP 66, für Kleinspannungs-Geräte (Option)

Nach Montage des Kabels
Reste der Membrane entfernen.

6.2 Elektrischer Anschluss PA 1

Platine im Unterteil:

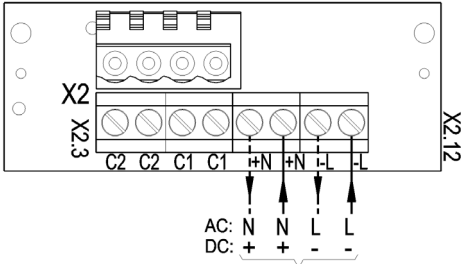
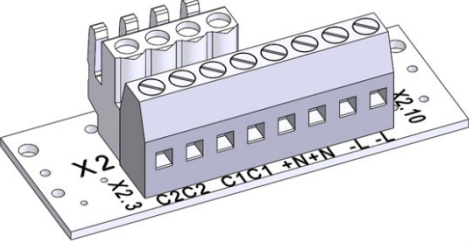

Betriebsspannungsanschluss

6.3 Elektrischer Anschluss PA X 1-05

Gemeinsamer Anschluss von Blitzleuchte und Schallgeber (Werkseinstellung)

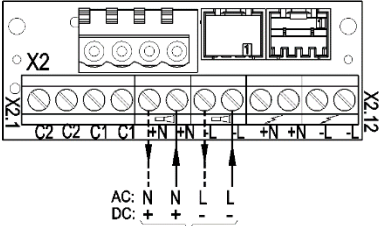
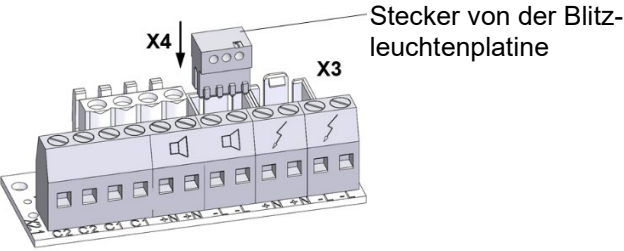

Betriebsspannungsanschluss

Getrennter Anschluss von Blitzleuchte und Schallgeber

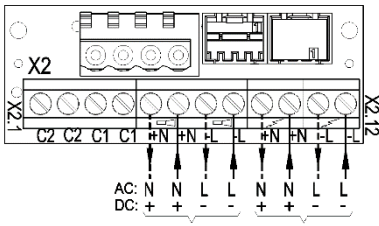
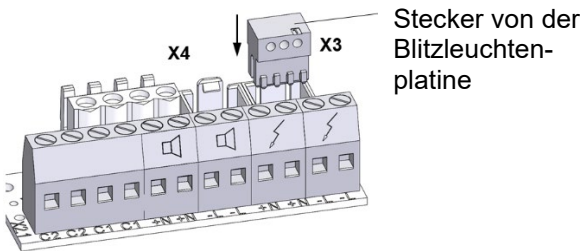

Betriebsspannungsanschluss Schallgeber Betriebsspannungsanschluss Blitzleuchte

7. Toneinstellungen (auf der Treiberplatine im Oberteil)

Der gewünschte Ton wird mit dem Tonartenschalter **S3** (auf der Treiberplatine im Oberteil) ausgewählt. Die möglichen Töne sind in der Tonartentabelle im Anhang beschrieben. Nach Anlegen der Versorgungsspannung wird der Ton erzeugt.

DC-Version und 48 AC

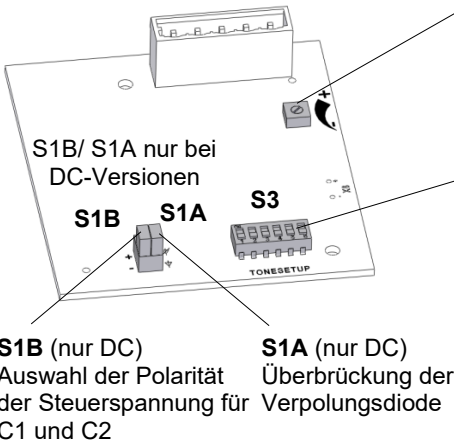

Lautstärkereglер
Hinweis:
Um EN54-3 konform zu sein,
muss sich der Lautstärkereglер
in der Maximal-Position befinden.

AC-Version

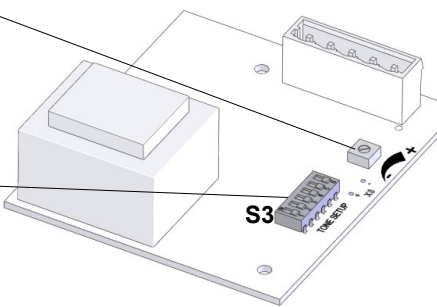

S1B S1A + - - +	Diode nicht überbrückt Polarität negativ Werkseinstellung
S1B S1A + - - +	Diode nicht überbrückt Polarität positiv
S1B S1A + - + -	Diode überbrückt Polarität negativ
S1B S1A + - + -	Diode überbrückt Polarität positiv

7.1 Änderung der Töne durch externe Ansteuerung

Für Anwendungen, die zusätzlich zum Grundton weitere Töne benötigen, besteht die Möglichkeit, bis zu drei weiteren Tonarten mithilfe der folgenden elektrischen Ansteuerungen zu erreichen.

Grundsätzlich wird erst der gewünschte Grundton (J, siehe Tonartentabelle im Anhang) mit dem Tonartenschalter S3 auf der Treiberplatine eingestellt. Die korrespondierenden zusätzlichen Töne (C1, C2, C1+C2) sind der Tabelle „Ansteuerung der Töne“ im Anhang zu entnehmen.

7.1.1 Tonstufenauswahl durch Steuereingang (TAS), DC- und AC-Versionen

DC-Version:

Hinweis: Versorgungsspannung immer zusammen mit den Steuereingängen angelegen.

Achtung: Ist die Steuerspannung größer als die Versorgungsspannung oder die Versorgungsspannung liegt nicht an, erfolgt die Betriebsstromversorgung über die Steuereingänge. Eine entsprechende Belastbarkeit muss dann gewährleistet sein.

Negative Ansteuerung: (Werkseinstellung)

Schalterstellung wie folgt vornehmen:

- S1A auf ∇ (Diode nicht überbrückt)
- Umschalter S1B auf „-“

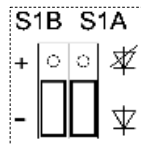

(auf der Treiberplatine)

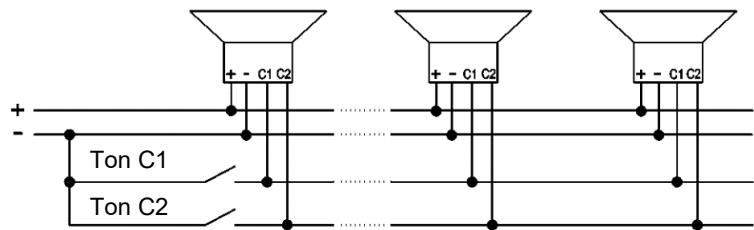
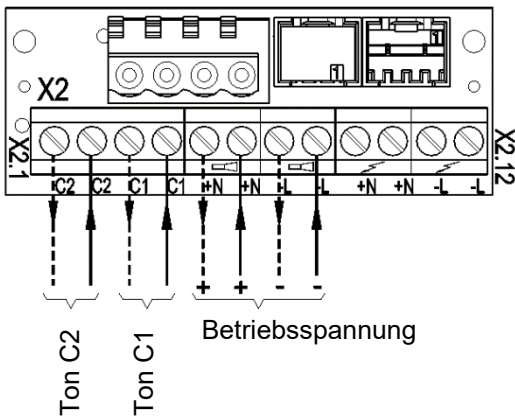

Positive Ansteuerung:

Schalterstellung wie folgt vornehmen:

- S1A auf ∇ (Diode nicht überbrückt)
- Umschalter S1B auf „+“ (positive Ansteuerung)

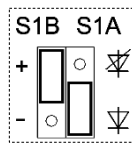

(auf der Treiberplatine)

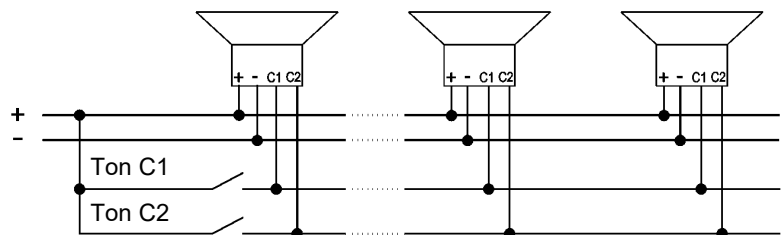
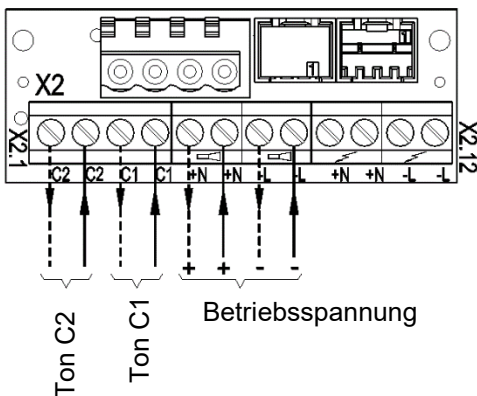

AC-Version:

Hinweis: Versorgungsspannung immer zusammen mit den Steuereingängen angelegen.

24 V AC/ 115/ 230 V AC: Phase „L“ der Versorgungsspannung an die Steuereingänge C1 bzw. C2 anlegen.

Nur 48 V AC: „N“ der Versorgungsspannung an die Steuereingänge C1 bzw. C2 anlegen.

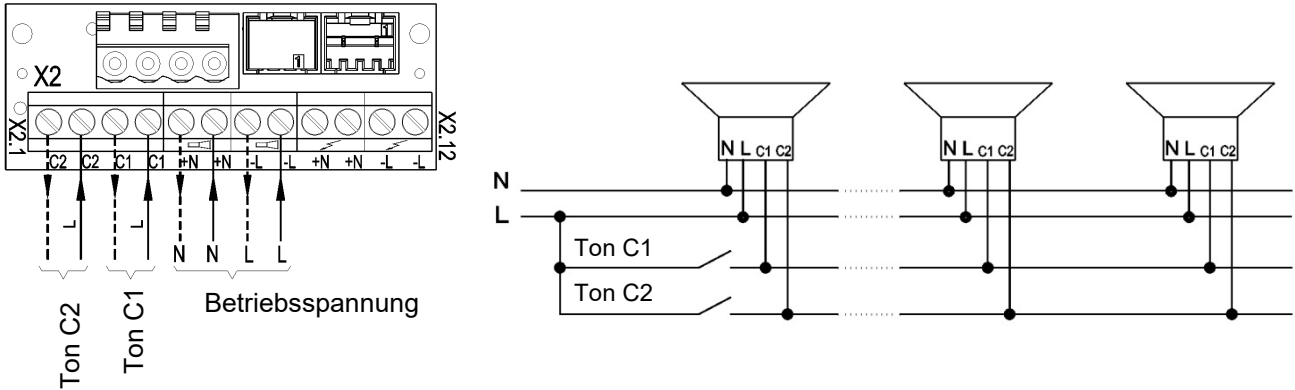

7.1.2 Tonstufenauswahl durch Versorgung über Steuereingang (TAV) – alle DC-Versionen

Hinweis: Nur bei DC-Version anwenden!

Der Schallgeber kann über die Steuereingänge C1 bzw. C2 auf der Anschlussplatine mit Betriebsspannung versorgt werden. Versorgung und Tonstufenauswahl erfolgt somit gleichzeitig.

Schalterstellung wie folgt vornehmen:

- **S1A** auf (Diode nicht überbrückt)
- Umschalter **S1B** auf „+“

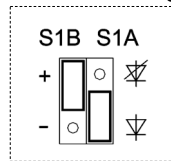

(auf der Treiberplatine)

- Minuspol auf der Anschlussplatine anschließen.
- Pluspol auf der Anschlussplatine anschließen. Der Grundton (♯) wird erzeugt.
- Anschluss der positiven Spannung an C1 auf der Anschlussplatine erzeugt Ton C1.
- Anschluss der positiven Spannung an C2 auf der Anschlussplatine erzeugt Ton C2.
- Gleichzeitiger Anschluss der positiven Spannung an C1 und C2 auf der Anschlussplatine erzeugt Ton „C1+C2“.

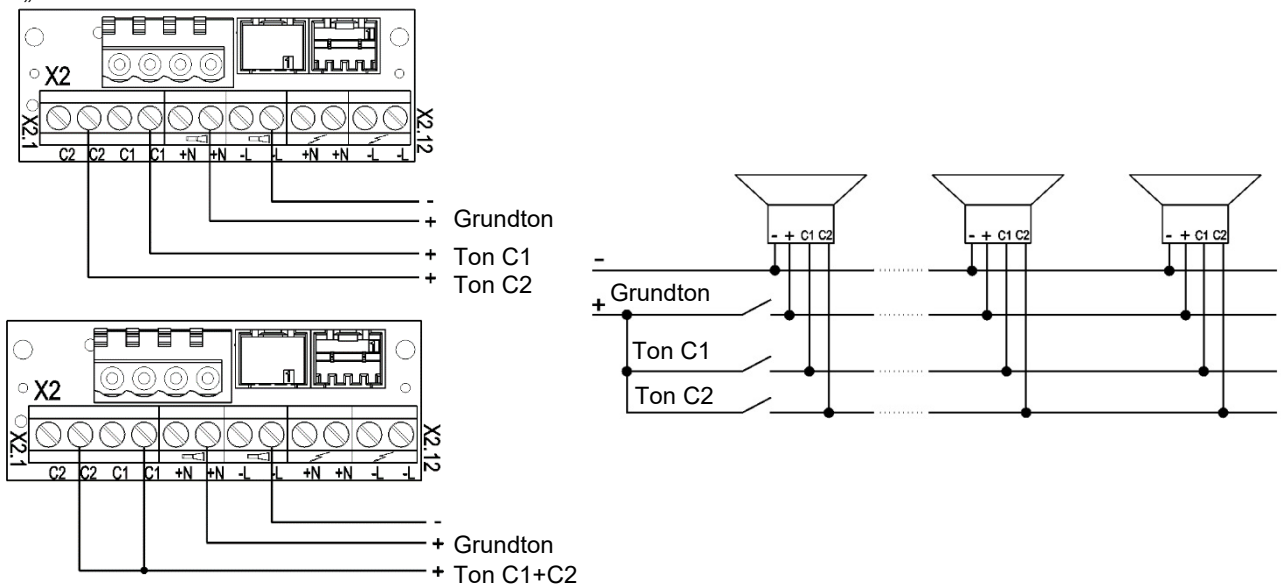

7.1.3 Tonstufenauswahl durch Verpolung (TAR) – alle DC-Versionen (außer Option –SSM)

Hinweis: Nur bei DC-Version anwenden!

Nicht bei –SSM-Versionen anwenden!

Die Steuereingänge C1 und C2 dürfen auf der Anschlussplatine nicht beschaltet werden!

Schalterstellung wie folgt vornehmen:

- S1A auf ∇ (Diode überbrückt)
- und Umschalter S1B auf „+“

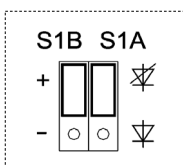

(auf der Treiberplatine)

Durch Verpolung der Betriebsspannung zum Grundton (♩) kann zusätzlich Ton „C1+C2“ gewählt werden:

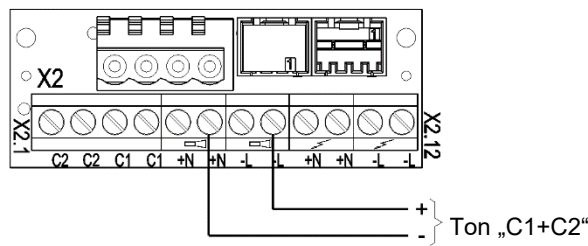
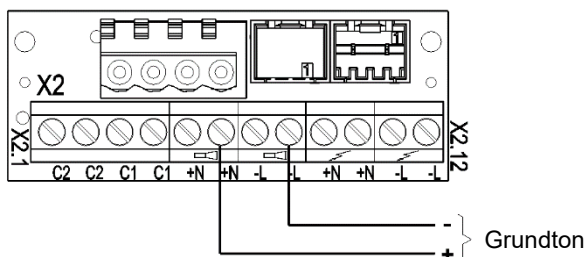

8. Option

–SSM (Soft-Start-Modul, nur 24V DC)

Die Einschaltstromspitze wird begrenzt auf:

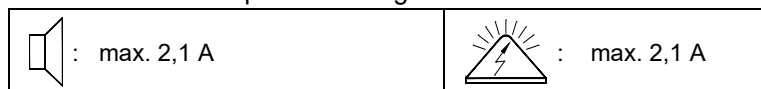

Die Betriebsspannung wird erst ab >7 V zum Betriebsmittel durchgeschaltet.

Betriebsspannungsbereich: 18 V – 30 V DC

Position des Widerstands (1kOhm) wie folgt vornehmen:

- Den Widerstand zur Leitungsüberwachung immer im letzten Gerät montieren.
- Bei getrenntem Anschluss von Schallgeber und Blitzleuchte Position des zweiten Widerstandes siehe unten.
- Nicht benötigte Widerstände entfernen.

Gemeinsamer Anschluss von Schallgeber und Blitzleuchte:

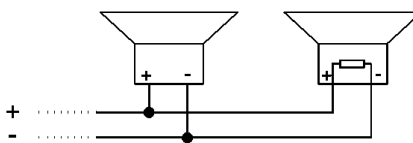
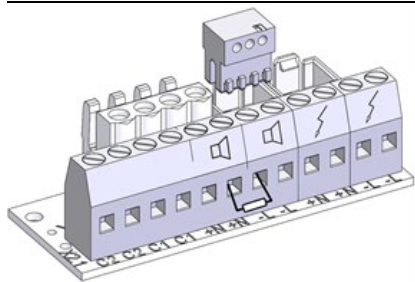

Getrennter Anschluss von Schallgeber und Blitzleuchte:

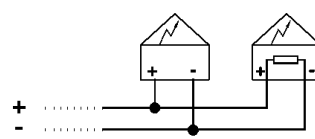
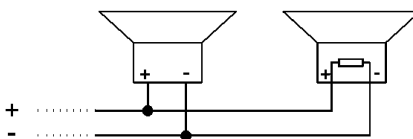
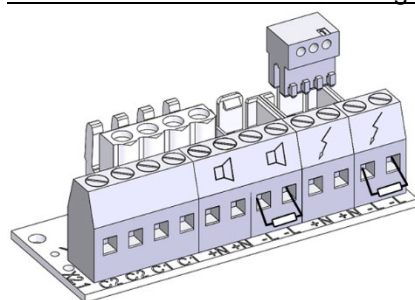

9. Zubehör

Artikel-Nr.	Bezeichnung
28300000002	Plombierstopfen, 4er-Pack
28912000000	Ersatzverriegelungsbolzen, 4er-Pack
28300000004	Flächendichtung
28300000007	Schalttafeleinbau-Kit PA 1

10. Wartung, Service, Instandhaltung

- Bei allen Arbeiten am Gerät [Sicherheitshinweise](#) beachten.

Das Gerät erfordert keine besondere Wartung.

- Äußere Reinigung mit einer schwachen Seifenlösung ohne Verwendung von Lösungsmittel vornehmen.
- Austausch von Komponenten nur mit Originalersatzteilen.
- Reparaturen grundsätzlich nur im Herstellerwerk ausführen lassen.

Umbauten, Änderungen, fehlerhafter und unzulässiger Einsatz sowie die Nichtbeachtung der Hinweise dieser Betriebsanleitung schließen eine Gewährleistung aus.

11. Außerbetriebnahme, Demontage und Entsorgung

- Bei allen Arbeiten am Gerät [Sicherheitshinweise](#) beachten.

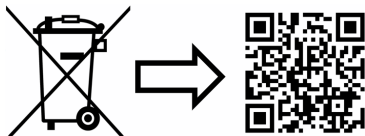

www.pfannenberg.com/disposal

Content

1. Intended use	1
2. Scope of delivery	1
3. Dimensions	2
4. Technical data	2
4.1 General	2
4.2 Electrical data AC	3
4.3 Electrical data DC	3
5. Approvals	4
6. Commissioning	6
6.1 Safety information	6
6.2 Electrical connection PA 1	7
6.3 Electrical connection PA X 1-05	7
7. Tone settings (on the driver board in the upper part)	7
7.1 Changing the tones by external control	8
7.1.1 Stage selection via control input (TAS), AC and DC versions	8
7.1.2 Stage selection by supply via control input (TAV) – all DC versions	9
7.1.3 Stage selection by reverse polarity (TAR) - all DC versions (except option –SSM)	10
8. Option	10
9. Accessories	11
10. Maintenance, service, repairs	11
11. Decommissioning, dismantling and disposal	11
Annex “Tone type table” and “Control of tones”	

1. Intended use

Sounders of the PA series are designed for the signaling of e.g. hazardous conditions in industry, trade and construction areas. There is also the possibility of visual signaling when the sounder/flashing light combination (PA X 1-05) is used.

The sounders produce acoustic signals in 80 different tones, which can be selected using an internal switch. The external control can be used to switch over to a maximum of 3 further tones.

The devices must only be operated when undamaged and within the specified parameters. The function of the device can only be guaranteed if the upper and lower parts are correctly joined together.

The devices are designed for indoor and outdoor use and are only intended for fixed installation.

2. Scope of delivery

The scope of delivery consists of:

- 1x Signaling device
- 1x Diaphragm nipple M20
- 1x Quick guide
- 1x Resistor (only for –SSM versions)

3. Dimensions

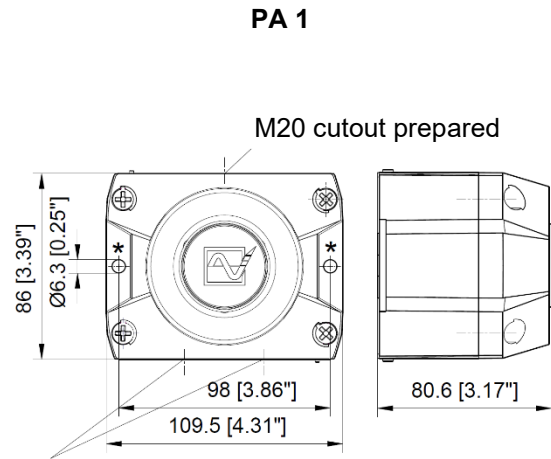

M20 cutout prepared

* M6 screw max., tightening torque 4 Nm

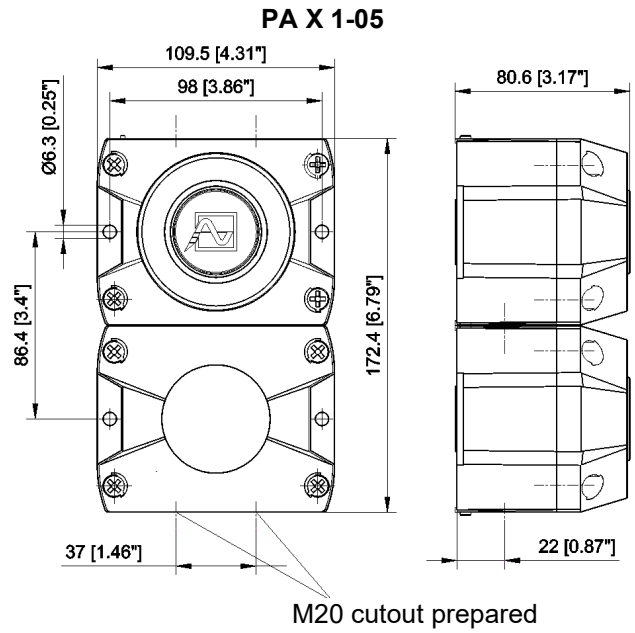

M20 cutout prepared

Drilling pattern inside the housing (PA 1)

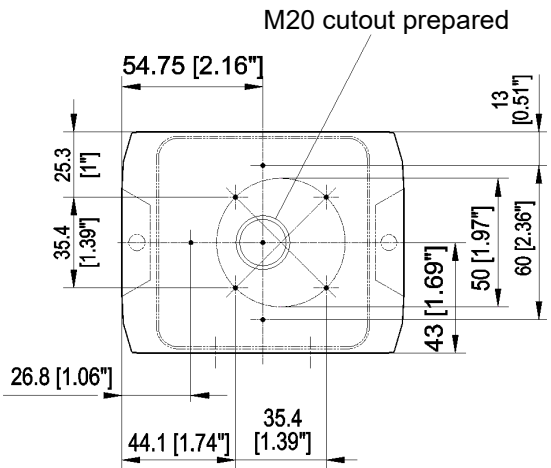

Drilling pattern inside the housing (PA X 1-05)

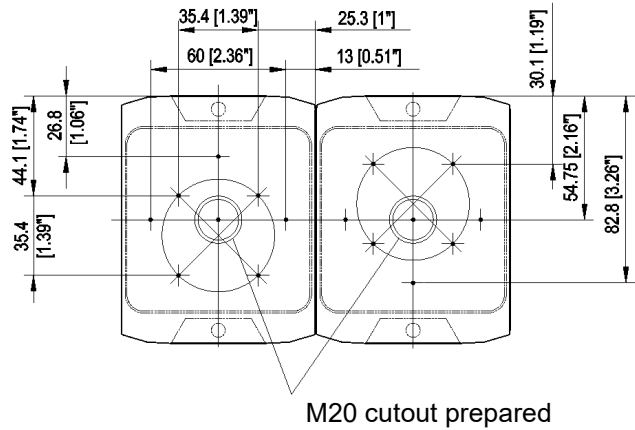

M20 cutout prepared

4. Technical data

4.1 General

	PA 1	PA X 1-05
Max. sound level	105 dB (A) 1m	
Volume control	max. -12dB	
Tones	80	
Flash energy	-	5 J
Flash frequency	-	1 Hz
Duty cycle	100%	
Connecting terminals	0.14 - 2.5mm ² fine stranded / AWG24 - AWG 14	
Ingress protection	IP 66 (EN 60529), Type 4 & 4x	
Impact strength	IK08 (EN 50102)	
Protection class	II  double insulated equipment	

Operating temperature	-40 °C...+55 °C	
Storage temperature	-40 °C...+70 °C	
Max. rel. air humidity	90%	
Cable inlet	4x M20 pre-embossed	5x M20 pre-embossed
Sealing range of the feed-through grommet	7 – 13 mm	A cable gland with a sufficient degree of protection must be provided when cable diameters of < 7 mm are used.
Housing material	PC/ ABS Blend	
Lens material	PC	
Installation position	any	
Lens colors	transparent, white, yellow, amber, red, green, blue	

4.2 Electrical data AC



	PA 1				PA X 1-05		
Rated voltage (See approvals for limit values)	24 V 50/60 Hz	48 V 50/60 Hz	115 V 50/60 Hz	230 V 50/60 Hz	24 V 50/60 Hz	115 V 50/60 Hz	230 V 50/60 Hz
Voltage range	18 – 30 V	44 – 52 V	95 – 127 V	195 – 253 V	18 – 30V	95 – 127V	195 – 253V
Sounder current consumption (max)	150 mA	150 mA	30 mA	16 mA	150 mA	30 mA	16 mA
Flashing light current consumption (max)	-	-	-	-	800 mA	120 mA	90 mA
Power consumption	4.5 VA	9 VA	4.5 VA	4.5 VA	34.5 VA	18.5 VA	25 VA

4.3 Electrical data DC

	PA 1		PA X 1-05		
Rated voltage (See approvals for limit values)	24 V or 12 – 48 V	120 V DC	12 V	24 V	48 V
Voltage range	10 – 57 V	108 – 132 V	10 – 15 V	18 – 30 V	40 – 57 V
Sounder current consumption (max)	80 mA	30 mA	25 mA	70 mA	80 mA
Flashing light current consumption (max)	-		700 mA	360 mA	170 mA
Power consumption	12 – 48 V: 4 W 24 V: 2 W	3.6 W	8 W	11.5 W	11.5 W

5. Approvals

(Approvals are valid for marked devices)

Construction Product Regulation (CPR) (305/2011/EU)  12 0786 In preparation:  22 0843	PA 1: DoP-No.: 03CPR2013-06-07 PA X 1-05: DoP-No.: 05CPR2013-06-07				
		PA 1		PA X 1-05	
	Options	-SSM (24V DC)			
	Rated voltage	24 – 48 V DC		24V DC	48V DC
	Voltage range in accordance with EN54-3, EN54-23	18 V – 57 V Option: -SSM (18 V – 30 V)		18 - 30V	40 - 57V
	Flashing light lens color	-		red, clear	
	Tone	compliant with the Construction Product Regulation (CPR) (305/2011/EU			
		2	1200Hz-500Hz (Sawtooth) DIN/PFEER P.T.A.P.		
		15	500Hz-1200Hz (Slow whoop)		
		60	825Hz (Continuous tone)		
	104	660Hz (Interrupted tone)			
	131	800Hz/ 1000Hz (Alternating tone)			
	146	544Hz/ 440Hz (NF S 32-001)			
Coverage volume	EN54-3: see document 30303-005-1		EN 54-23 category O: see document 30303-005-1		
Environmental protection class	Type B				
Installation position	any		see document 30303-005-1		
The test was performed using the supplied diaphragm nipple and the outer mounting bores.					
VdS	PA 1		PA X 1-05		
	G 212115		G 212188		
	See Construction Product Regulation (CPR) (305/2011/EU) for data				
DNV	TAA00001R0				
MED	MEDB00002BH				
CNBOP	3558/2019		3560/2019		
UL, cUL	S7256				
		Rated Voltage	Audible-signal Appliance Fire Alarm Equipment ULSZ, ULSZ7	Audible and Visual signal Appliance General Signal Equipment UCST, UCST7 and UEES, UEES7	
	PA 1	24V – 48V DC (Fire Alarm Equipment) 12V – 48V DC (General Signal Equipment)	x Special application, limited operating voltage range 18 – 57 V DC	x	
	PA 1 PA X 1-05	24V AC 115V AC 230V AC	--	x	
	PA X 1-05	12V DC 24V DC 48V DC	--	x	

No approvals for PA1, 48V AC.

PATROL sounders and combined units **PA 1/ PA X 1-05** comply with the limits for a Class B digital device, pursuant to part 15 of the FCC Rules.

UL/ cUL specifications:

Suitable for indoor and outdoor use. Signaling area: see document 30303-005-1.

Cable gland entries:

Conduit installation needs to be UL/ cUL listed fittings suitable for knockout openings. The supply wiring has to be enclosed in metal conduits for products for Fire Alarm Use.

According to CSA-C22.2 No. 205-M1983 clause 4.3.4 the connection is limited to max. three leads.

Installation:

The units shall be installed indoors or outdoors in accordance with the manufacturer’s installation instructions as well as the National Electrical Code (NFPA 70) and the National Fire Alarm Code (NFPA 72) for the units evaluated for Public Fire Alarm applications in the U.S. In Canada, they shall be installed in accordance with the Canadian Electrical Code, Part 1 and the Standard for the Installation of Fire Alarm Systems CAN/ULC-S524-M91 for the units evaluated for Public Fire Alarm applications. The installation shall also be in a manner acceptable with the local authority having jurisdiction.

For audible application for Fire Alarm Service use both terminals for connection. Break wire run to provide Electrical Supervision (see UL 464 clause 39.1e). The tone no. 111 is to be used for evacuation use only (see UL 464 clause 39.1e)

cUL directional characteristics for the horn:

AXIS	ANGLE	dBA
Horizontal	32 deg. left or right	-3
Horizontal	28 deg. left or right	-6
Vertical	32 deg. left or right	-3
Vertical	28 deg. left or right	-6

Min. Output sound pressure level: [dB(A)]:





Type	Voltage	UL 464 dB(A) at 10 ft ++	CAN/ULc-S525-07
PA 1-24 DC	18V DC	77.1 (for tone 113)	86.2 (for tone 60)
Tone no. 2, 15, 60, 104, 131, 146, 111, 112, and 113 was used for this test.			

Connecting cables:



6. Commissioning

6.1 Safety information

	<p>DANGER - Danger to life due to electric shock Voltage-carrying devices and exposed connection cables may cause electric shocks and serious accidents.</p> <ul style="list-style-type: none"> ➤ Only trained and authorized electricians may work on electrical connections. ➤ Disconnect all supply lines from mains before installation and secure them against reconnection. Always ensure absence of voltage. ➤ Wait for the discharge phase of 5 minutes for the electrical components. The device should only be opened afterwards. ➤ The operating voltage must only be applied when the housing is firmly closed.
	<p>WARNING - Danger due to unauthorized use of the devices Improper use may lead to serious accidents.</p> <ul style="list-style-type: none"> ➤ Ensure that the connection cable is protected against pulling and twisting during installation. The devices are only intended for fixed installation. <p>To ensure long-term function:</p> <ul style="list-style-type: none"> ➤ Do not mount the sound projector pointing upwards in dusty environments or outdoors.
	<p>DANGER - Danger due to damage to the devices Non-compliance with the information on the type plate can lead to serious accidents.</p> <ul style="list-style-type: none"> ➤ Always observe the information on the type plate when installing and maintaining the devices.
	<p>CAUTION - Risk of injury due to sharp edges or heated components</p> <ul style="list-style-type: none"> ➤ Wear gloves during any installation, assembly or service/maintenance work. ➤ Perform wiring tasks at a distance from sharp edges, corners and internal components.
	<p>CAUTION - Risk of hearing impairment ➤ Wear sound insulation equipment during work/testing to prevent hearing impairment.</p> <p>CAUTION - Impairment of vision When using the sounder/flashing light combination:</p> <ul style="list-style-type: none"> ➤ Avoid constant, direct glances into the activated lights to prevent impairment of vision.

Opening the housing

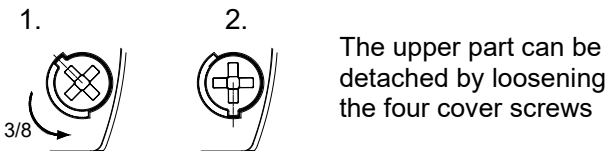

Closing the housing

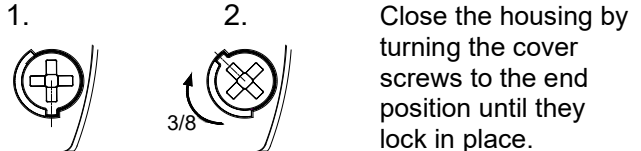

The device is delivered in an unsealed condition.
Sealing plugs for the housing screws are available as accessories.

Cable feed-throughs

The supplied diaphragm nipple can be replaced by a cable gland or by an M12 plug-in connector with a flange dimension of M20.

- Only cable glands with a degree of protection of at least IP66 should be fitted to the corresponding openings.

Cable diameters of <7 mm require a cable gland with a sufficient degree of protection.

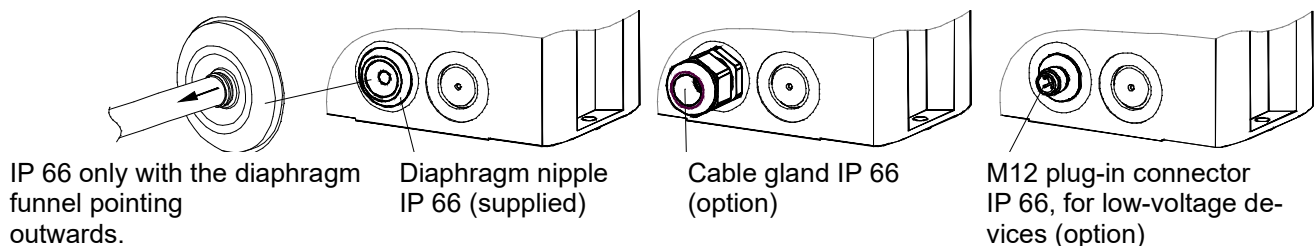

Remove the remains of the diaphragm after the cable has been fitted.

6.2 Electrical connection PA 1

Circuit board in lower part:

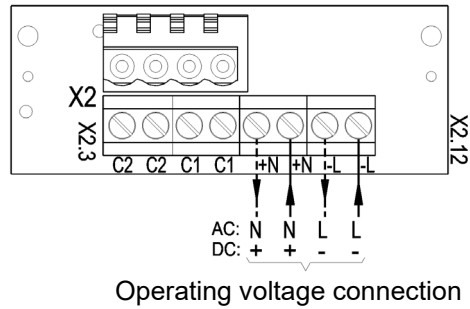
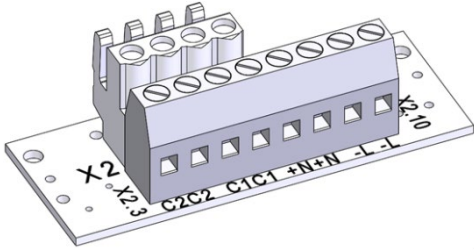

6.3 Electrical connection PA X 1-05

Common connection of flashing light and sounder (Factory setting)

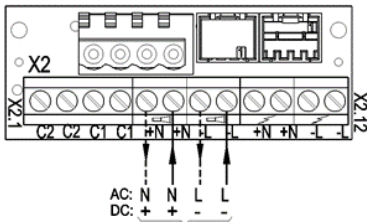
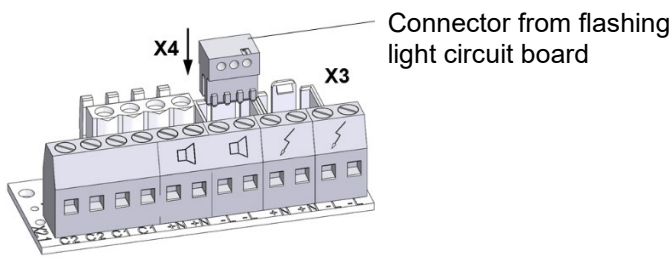

Separate connection of flashing light and sounder

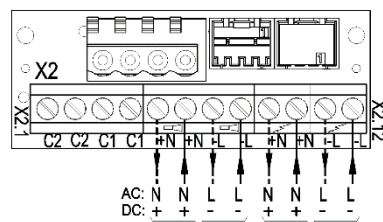
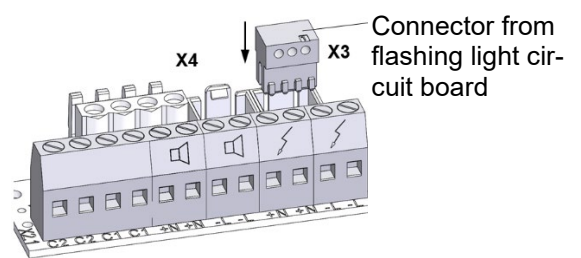

7. Tone settings (on the driver board in the upper part)

The desired tone can be selected using the tone selector switch **S3** (on the driver board in the upper part). The possible tones are described in the tone type table in the Annex. The tone is generated after the supply voltage is applied.

DC version and 48 V AC

AC version

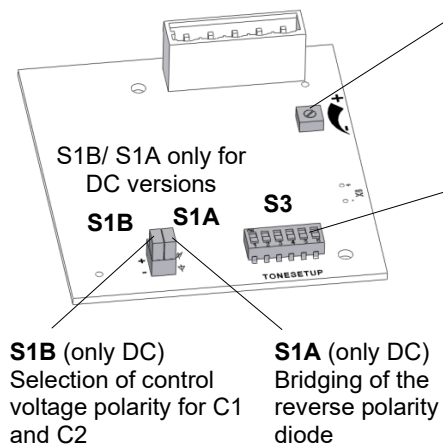

Volume control
Note:
The volume control must be in the maximum position in order to conform to EN54-3.

Tone selector switch **S3**

S1B S1A + - + -	Diode not bridged Polarity negative Factory setting
S1B S1A + - + -	Diode not bridged Polarity positive
S1B S1A + - + -	Diode bridged Polarity negative
S1B S1A + - + -	Diode bridged Polarity positive

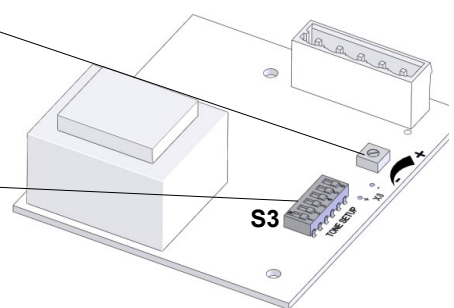

7.1 Changing the tones by external control

It is possible to obtain up to three additional tone types using the following electrical controls for applications that require additional tones in addition to the base tone.

The desired base tone (J, see tone type table in the Annex) is always set first with the tone selector switch **S3** on the driver board. The corresponding additional tones (C1, C2, C1+C2) can be found in the "Control of tones" table in the Annex.

7.1.1 Stage selection via control input (TAS), AC and DC versions

DC version:

Note: Always apply the supply voltage together with the control inputs.

Caution: If the control voltage is higher than the supply voltage or the supply voltage is not present at all, the operating current will be supplied via the control inputs. A corresponding carrying capacity has to then be ensured.

Negative control: (Factory setting)

Switch setting should be as follows:

- **S1A** to ∇ (diode not bridged)
- Changeover switch **S1B** to "-"

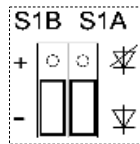

(on the driver board)

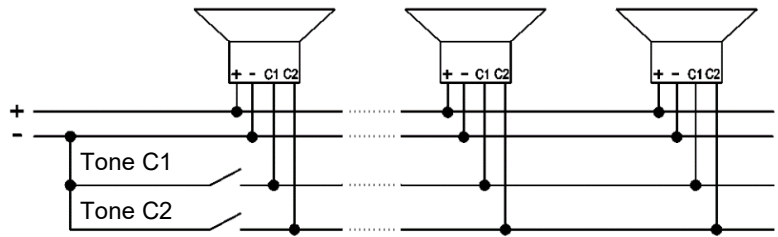
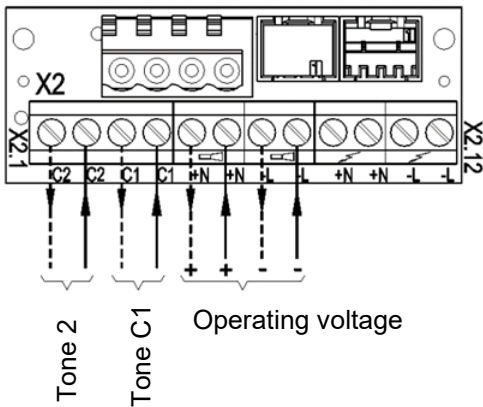

Positive control:

Switch setting should be as follows:

- **S1A** to ∇ (diode not bridged)
- Changeover switch **S1B** to "+" (positive control)

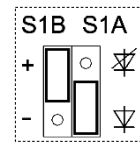

(on the driver board)

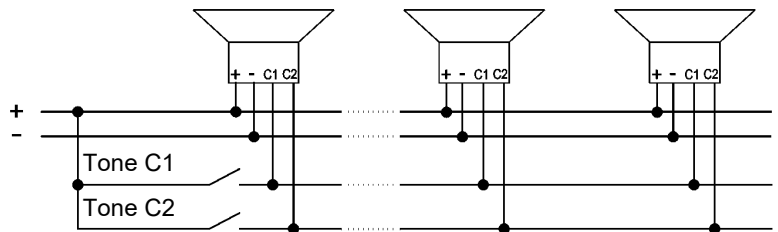
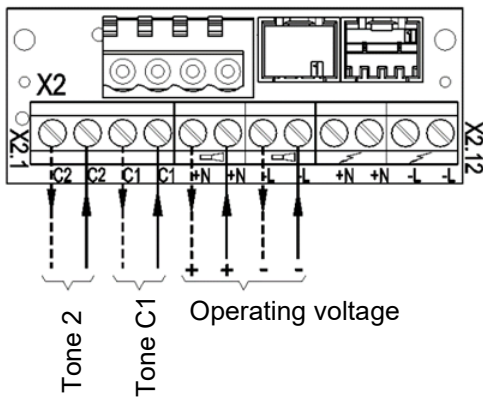

AC version:

Note: Always apply the supply voltage together with the control inputs.

24 V AC/ 115/ 230 V AC: Apply phase "L" of the supply voltage to the control inputs C1 / C2.

Only 48 V AC: Apply "N" of the supply voltage to the control inputs C1 / C2.

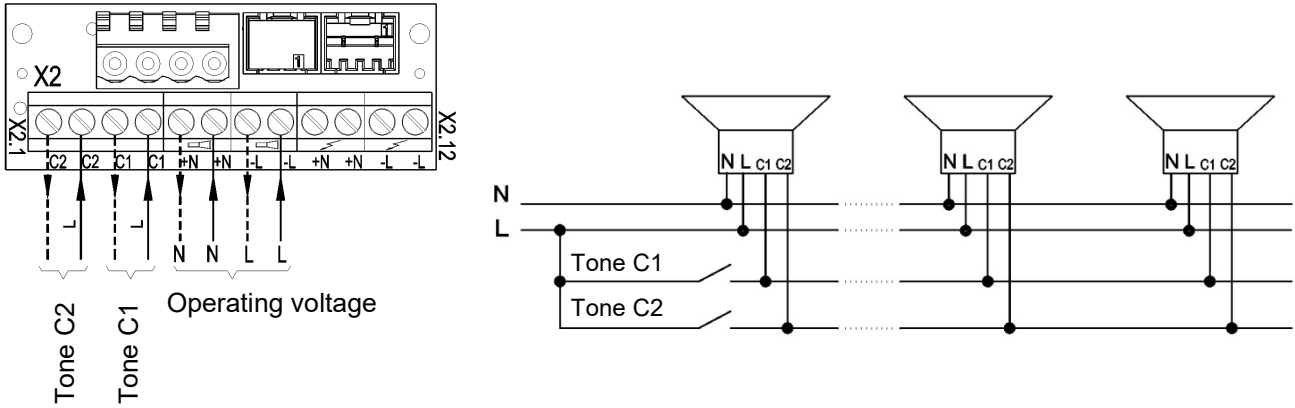

7.1.2 Stage selection by supply via control input (TAV) – all DC versions

Note: Only applicable to DC version!

The sounder can be supplied with operating voltage via the control inputs C1 / C2 on the connection board. Supply and stage selection therefore take place simultaneously.

Switch setting should be as follows:

- **S1A** to ∇ (diode not bridged)
- Changeover switch **S1B** to "+"

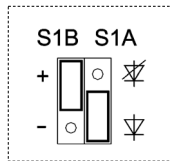

(on the driver board)

- Connect the negative terminal on the connection board.
- Connect the positive terminal on the connection board. The basic tone (∇) is generated.
- Connection of the positive voltage to C1 on the connection board generates tone C1.
- Connection of the positive voltage to C2 on the connection board generates tone C2.
- Simultaneous connection of the positive voltage to C1 and C2 on the connection board generates tone "C1+C2".

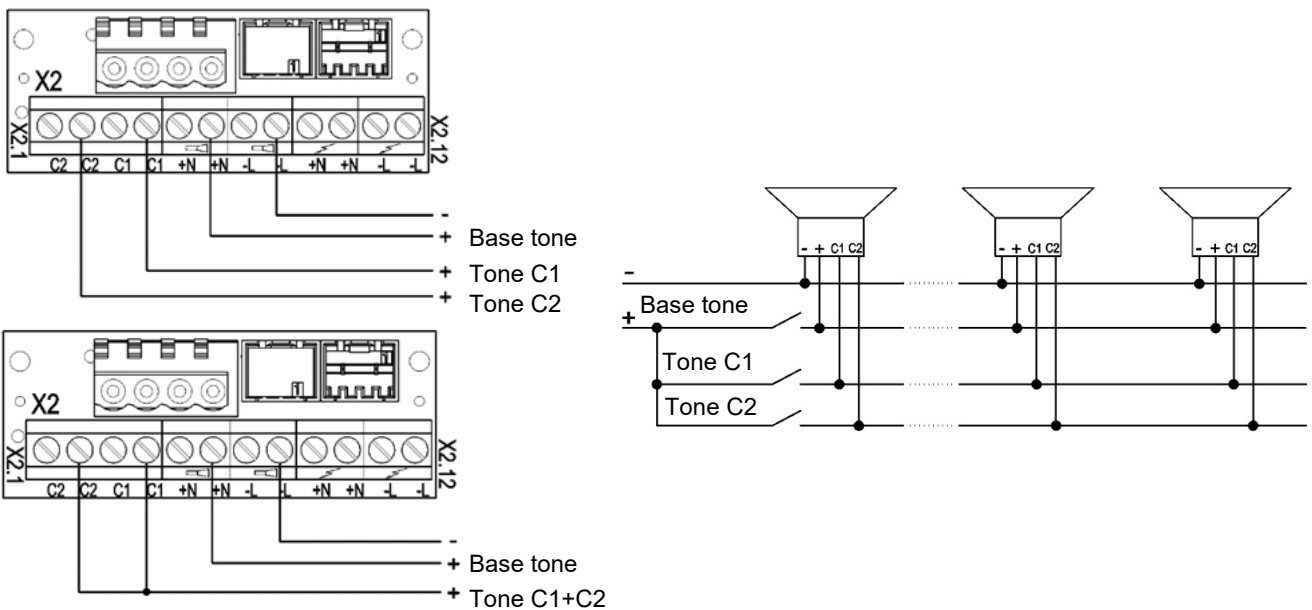

7.1.3 Stage selection by reverse polarity (TAR) - all DC versions (except option –SSM)

Note: Only applicable to DC version!
 Not applicable to –SSM versions!
 The control inputs C1 and C2 must not be connected on the connection board!

Switch setting should be as follows:

- **S1A** to ∇ (diode bridged)
- and changeover switch **S1B** to "+"

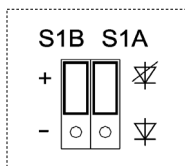

(on the driver board)

Tone "C1+C2" can also be selected by reversing the polarity of the operating voltage to the basic tone (♫):

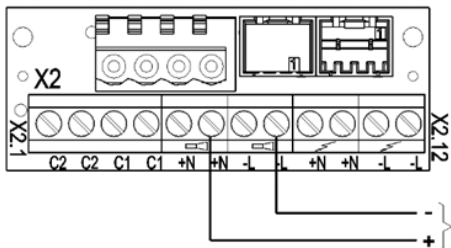

Base tone

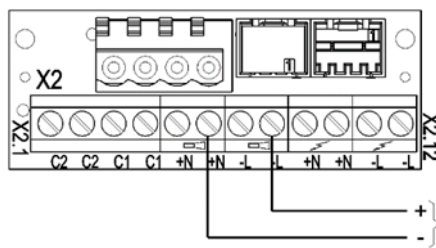

Tone "C1+C2"

8. Option

–SSM (soft-start module, only 24V DC)

The inrush current peak is limited to:



The operating voltage is only switched through to the operating equipment from >7 V.
 Operating voltage range: 18 V – 30 V DC

Positioning of the resistor (1kOhm) is as follows:

- Always mount the resistor for line monitoring in the last device.
- See below for the position of the second resistor if the sounder and flashing light are connected separately.
- Remove any resistors that are not required.

Common connection of sounder and flashing light:

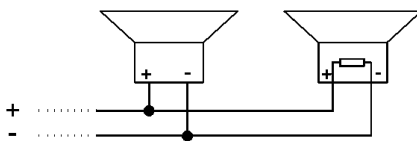
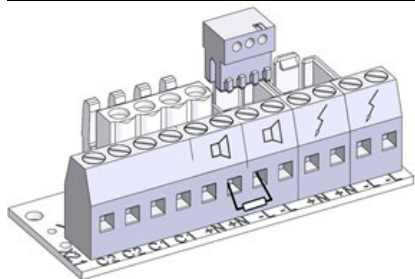

Separate connection of sounder and flashing light:

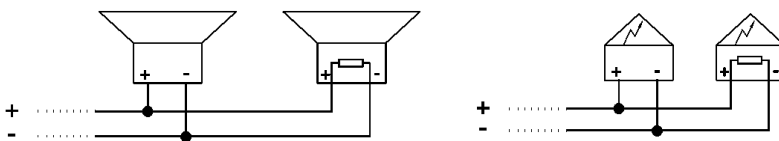
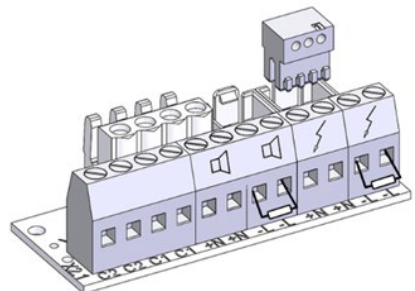

9. Accessories

Item No.	Designation
28300000002	Sealing plug, 4-pack
28912000000	Spare locking bolt, 4-pack
28300000004	Surface seal
28300000007	Control panel mounting kit PA 1

10. Maintenance, service, repairs

- Observe the [Safety information](#) during all work on the device.

The device requires no special maintenance.

- Carry out external cleaning using a weak soap solution without using any solvents.
- Only replace components using original spare parts.
- Only have repairs carried out at the manufacturer's premises.

Conversions, modifications, improper and impermissible use as well as failure to observe the notes in these operating instructions shall void any warranty.

11. Decommissioning, dismantling and disposal

- Observe the [Safety information](#) during all work on the device.

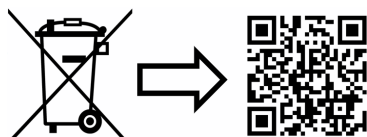

www.pfannenber.com/disposal

EU

Pfannenber 
ELECTRO-TECHNOLOGY FOR INDUSTRY

Pfannenber GmbH
Werner-Witt-Straße 1
D- 21035 Hamburg
Tel.: +49/ (0)40/ 734 12-0
Fax: +49/ (0)40/ 734 12-101
service@pfannenber.com
<http://www.pfannenber.com>

UK

Pfannenber 
ELECTRO-TECHNOLOGY FOR INDUSTRY

Pfannenber (UK) Ltd.
Unit 6C, Aspen Court, Bessemer Way
Centurion Business Park
S60 1FB Templeborough Rotherham
Tel. +44 1709 364844
Fax: +44 1709 364211
Email: info@pfannenber.co.uk
<http://www.pfannenber.com>

Sommaire

1. Utilisation conforme	1
2. Contenu de la livraison	1
3. Dimensions	2
4. Caractéristiques techniques	2
4.1 Généralités.....	2
4.2 Caractéristiques électriques CA	3
4.3 Caractéristiques électriques CC	3
5. Admissions	4
6. Mise en service	5
6.1 Consignes de sécurité	5
6.2 Branchement électrique PA 1	6
6.3 Branchement électrique PA X 1-05	6
7. Réglages du son (sur la platine pilote de la partie supérieure)	6
7.1 Modification des sons par activation externe.....	7
7.1.1 Sélections des sons par entrée de commande (TAS) – versions CA et CC.....	7
7.1.2 Sélection des sons par l'entrée de commande (TAS) – pour toutes les versions CC	8
7.1.3 Sélection des sons par inversion de polarité (TAR) – pour toutes les versions CC (sauf appareils équipés de l'option –SSM).....	9
8. Option	9
9. Accessoires	10
10. Maintenance, entretien, réparation	10
11. Mise hors service, démontage et élimination	10
Annexe « Tableau de sons » et « Activation des sons »	

1. Utilisation conforme

Les sirènes de la série PA sont conçues pour la signalisation des situations dangereuses dans l'industrie, le commerce et le secteur du bâtiment Il est également possible d'ajouter un système de signalisation visuelle dans le cas d'utilisation d'appareils combinés de signalisation visuelle et sonore (PA X 1-05).

Les sirènes génèrent des signaux sonores qui se déclinent en 80 sons différents. Ces sons peuvent être sélectionnés au moyen d'un commutateur interne. Il est possible de commuter jusqu'à 3 sons supplémentaires via une commande externe.

N'utilisez les appareils que s'ils sont en bon état et conforme aux caractéristiques spécifiées. Le fonctionnement de l'appareil n'est garanti que si les parties supérieure et inférieure ont été correctement assemblées.

Les appareils conviennent à une utilisation intérieure comme extérieure et sont uniquement destinés à une installation stationnaire.

2. Contenu de la livraison

La livraison se compose des éléments suivants :

- 1x appareil de signalisation
- 1x raccord fileté à membrane M20
- 1x guide rapide
- 1x résistance (uniquement sur la version –SSM)

3. Dimensions



Schéma de perçage de l'intérieur du boîtier (PA 1)



Schéma de perçage de l'intérieur du boîtier (PA X 1-05)

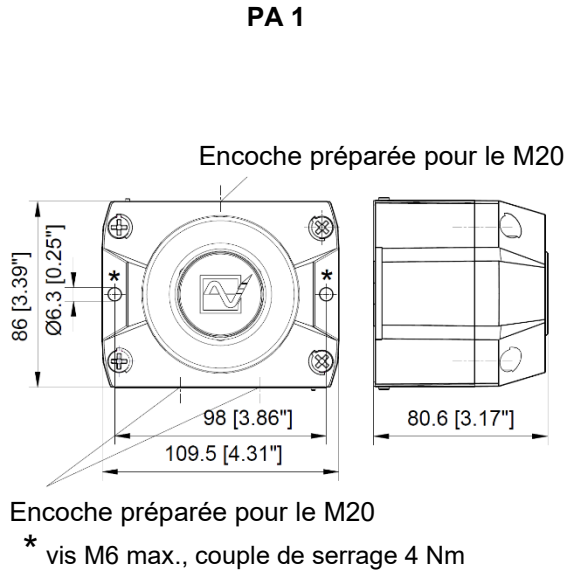

4. Caractéristiques techniques

4.1 Généralités

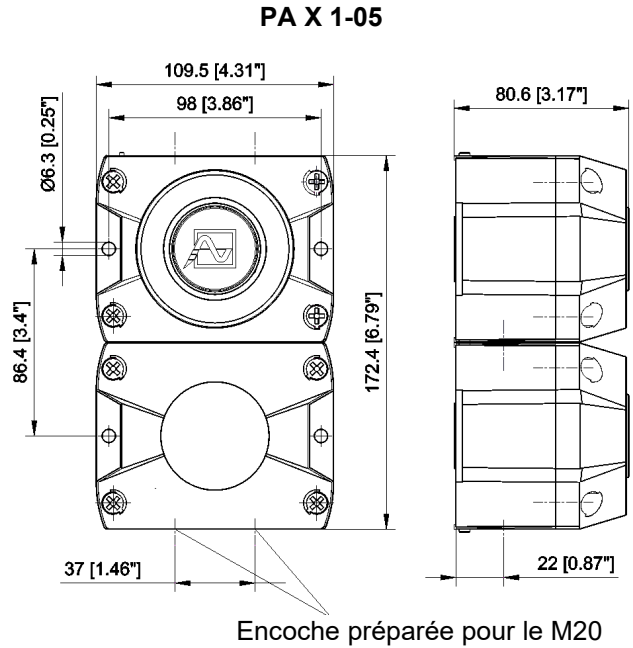
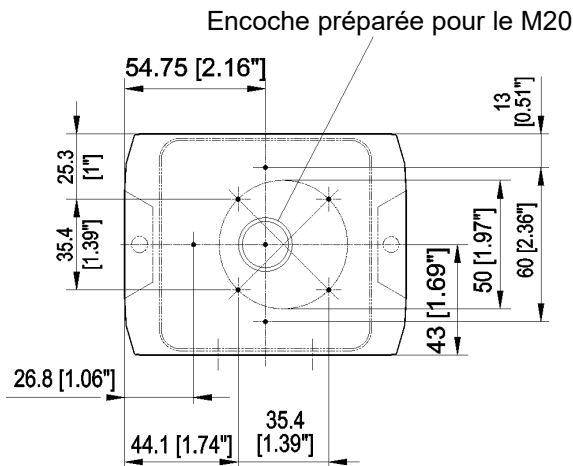
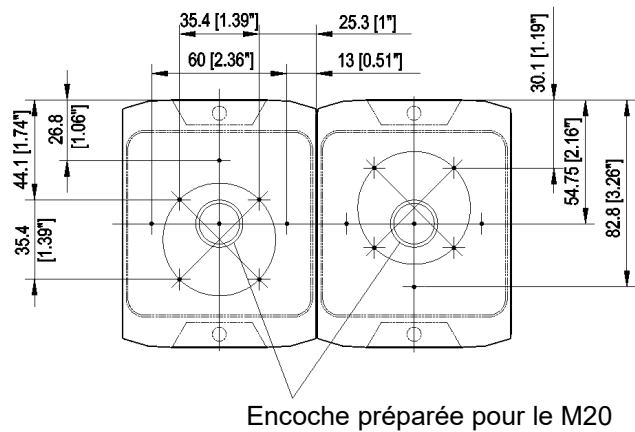
	PA 1	PA X 1-05
Niveau sonore maximal	105 dB (A) @ 1m	
Réglage du volume sonore	max. -12 dB	
Sons	80	
Puissance lumineuse	-	5 J
Fréquence du flash	-	1 Hz
Facteur de marche	100 %	
Bornes de connexion	0,14 - 2,5 mm ² à fil fin / AWG24 - AWG 14	
Indice de protection	IP 66 (EN 60529), type 4 & 4x	
Résistance aux chocs	IK08 (EN 50102)	
Classe de protection	II	

Température de service	-40 °C... +55 °C	
Température de stockage	-40 °C... +70 °C	
Humidité relative max.	90%	
Entrée de câbles	4x M20 avec empreinte préalable	5x M20 avec empreinte préalable
Zone d'étanchéité du passe-fils	7 – 13 mm En cas d'utilisation câbles de diamètre < 7 mm, veuillez prévoir un raccord de câble équipé d'un type de protection suffisant.	
Matériau du boîtier	PC/ ABS Blend	
Matériau du capot	PC	
Position de montage	au choix	
Couleurs du capot	transparent, blanc, jaune, orange, rouge, vert, bleu	

4.2 Caractéristiques électriques CA



	PA 1				PA X 1-05		
Tension assignée (pour les limites cf. Admissions)	24 V 50 / 60 Hz	48 V 50/60 Hz	115 V 50 / 60 Hz	230 V 50 / 60 Hz	24 V 50 / 60 Hz	115 V 50 / 60 Hz	230 V 50 / 60 Hz
Plage de tension de service	18 – 30 V	44 – 52 V	95 – 127 V	195 - 253 V	18 – 30 V	95 – 127 V	195 – 253 V
Consommation de courant sirènes (max)	150 mA	150 mA	30 mA	16 mA	150 mA	30 mA	16 mA
Consommation de courant des feux flash (max)	-	-	-	-	800 mA	120 mA	90 mA
Consommation d'énergie	4,5 VA	9 VA	4,5 VA	4,5 VA	34,5 VA	18,5 VA	25 VA

4.3 Caractéristiques électriques CC

	PA 1		PA X 1-05		
Tension assignée (pour les limites cf. Admissions)	24 V ou 12 – 48 V	120 V	12 V	24 V	48 V
Plage de tension de service	10 – 57 V	108 – 132 V	10 – 15 V	18 – 30 V	40 – 57 V
Consommation de courant sirènes (max)	80 mA	30 mA	25 mA	70 mA	80 mA
Consommation de courant des feux flash (max)	-	-	700 mA	360 mA	170 mA
Consommation d'énergie	12 – 48 V : 4 W 24 V : 2 W	3,6 W	8 W	11,5 W	11,5 W

5. Admissions





(Les admissions sont valables pour les appareils signalés)

Règlement sur les Produits de construction (305/2011/UE)  12 0786 En préparation :  22 0843	PA 1 : DoP-No.: 03CPR2013-06-07 PA X 1-05 : DoP-No.: 05CPR2013-06-07			
		PA 1	PA X 1-05	
	Options	-SSM (24 V CC)		
	Tension assignée	24 – 48 V CC	24 V CC	48V CC
	Plage de tension de service selon EN54-3, EN54-23	18 V – 57 V Option : -SSM (18 V – 30 V)	18 - 30 V	40 - 57 V
	Couleur du capot des feux flash	-	rouge, transparent	
	Son	Conforme au Règlement sur les Produits de construction (305/2011/UE) 1200 Hz-500 Hz (dent de scie DIN/PFEER P.T.A.P.) 500 Hz-1200 Hz (sirène montante/ Slow whoop) 825 Hz (son continu/ Continuous) 660 Hz (son intermittent/ Intermittent) 800 Hz/ 1000 Hz (Modulé bi-ton / Alternating) 544 Hz / 440 Hz (NF S 32-001)		
		2 15 60 104 131 146		
	Plage de signalisation	EN54-3 : Voir document 30303-005-1	EN 54-23 catégorie O : Voir document 30303-005-1	
	Classe de protection environnementale	Type B		
	Position de montage	au choix	Voir document 30303-005-1	
	Le test a été effectué en utilisant le raccord fileté de membrane livré ainsi que les perçages extérieurs de fixation.			
VdS	PA 1	PA X 1-05		
	G 212115	G 212188		
	Pour les caractéristiques, voir le Règlement sur les Produits de construction (305/2011/UE)			
DNV	TAA00001R0			
MED	MEDB00002BH			
CNBOP	3558/2019	3560/2019		
UL, cUL	S7256 UCST, UCST7, ULSZ, ULSZ7, UEES, UEES7 (pour plus d'informations, cf. page 4 et 5 de la partie en langue anglaise)			

PA1, 48V CA: Sans admissions.

6. Mise en service

6.1 Consignes de sécurité

	<p>DANGER - Danger de mort par décharge électrique</p> <p>Les appareils sous tension et les câbles de raccordement dénudés peuvent provoquer des décharges électriques et des accidents graves.</p> <ul style="list-style-type: none"> ➤ Les travaux sur les branchements électriques ne peuvent être effectués que par des professionnels agréés, formés en électrotechnique. ➤ Avant le montage, veuillez débrancher tous les câbles d'alimentation électrique et veillez à ce que le courant ne soit pas rétabli. Assurez-vous toujours de l'absence de tension. ➤ Attendez la fin de la phase de décharge de 5 minutes pour les composants électriques. L'appareil peut ensuite être ouvert. ➤ La tension de service ne doit être appliquée que lorsque le boîtier est solidement fermé.
	<p>AVERTISSEMENT - Risque lié à une utilisation non conforme des appareils</p> <p>Une utilisation non conforme peut entraîner des accidents graves.</p> <ul style="list-style-type: none"> ➤ Lors de l'installation, assurez-vous que le câble de raccordement est protégé contre la traction et la torsion. Les appareils sont uniquement destinés à une installation stationnaire. <p>Pour assurer un fonctionnement sur le long terme :</p> <ul style="list-style-type: none"> ➤ Ne montez pas le klaxon vers le haut dans des milieux poussiéreux ou à l'extérieur.
	<p>DANGER - Risques liés à la détérioration des appareils</p> <p>Le non-respect des indications de la plaque signalétique peut entraîner des accidents graves.</p> <ul style="list-style-type: none"> ➤ Lors de l'installation et de la maintenance des appareils, prenez toujours en compte les indications figurant sur la plaque signalétique.
	<p>ATTENTION - Risques de blessures par des arêtes vives ou des composants chauds</p> <ul style="list-style-type: none"> ➤ Portez des gants lors des travaux d'installation, de montage ou d'entretien / de maintenance. ➤ Réalisez le câblage à l'écart des arêtes vives, des coins pointus et des composants internes.
	<p>ATTENTION - Risques d'altération de l'ouïe</p> <ul style="list-style-type: none"> ➤ Veuillez porter un équipement anti-bruit pour prévenir toute altération de l'ouïe pendant votre travail ou lors des tests. <p>ATTENTION - Déficience de la vue</p> <p>Lors de l'utilisation d'appareils combinés de signalisation visuelle et sonore :</p> <ul style="list-style-type: none"> ➤ Pour éviter toute altération de la vision, évitez de regarder fixement et directement le feu flash activé.

Ouverture du boîtier



Fermeture du boîtier

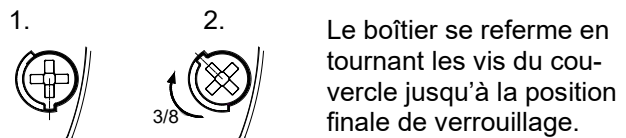

À la livraison, l'appareil n'est pas verrouillé.

Des bouchons de plombier sont disponibles dans les accessoires pour les vis du boîtier.

Passage des câbles

Le raccord fileté à membrane fourni peut être remplacé par un presse-étoupes à vis ou par un connecteur M12 avec une bride de dimension M20.

- Veuillez ne monter que des presse-étoupes ayant un type de protection supérieur ou égal à IP66 au niveau des perçages prévus à cet effet.

En cas d'utilisation câbles de diamètre < 7 mm, veuillez prévoir un raccord de câble équipé d'un type de protection suffisant.

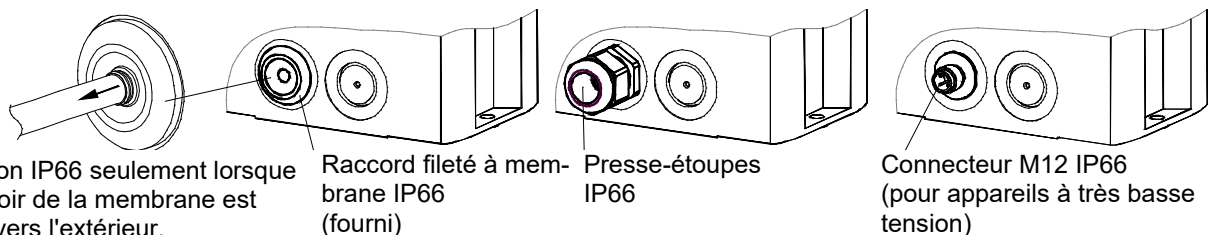

Après le montage du câble veuillez enlever le reste de la membrane.

6.2 Branchement électrique PA 1

Platine dans la partie inférieure:

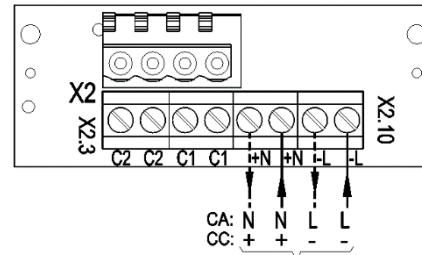
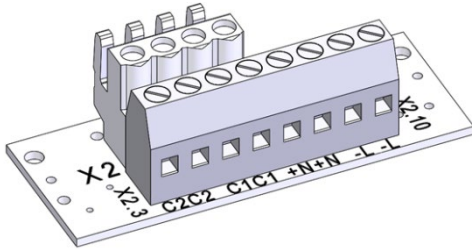

Raccordement de la tension de service

6.3 Branchement électrique PA X 1-05

Raccordement commun des feux flash et des sirènes
(Réglage d'usine)

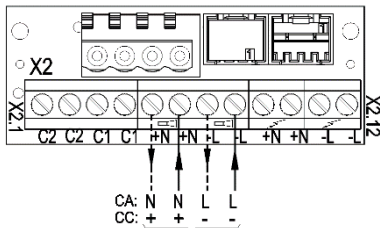
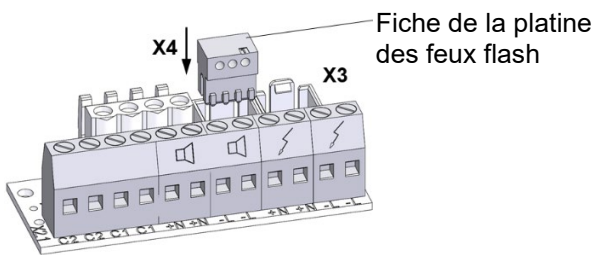

Raccordement de la tension de service

Raccordement séparé des feux flash et des sirènes

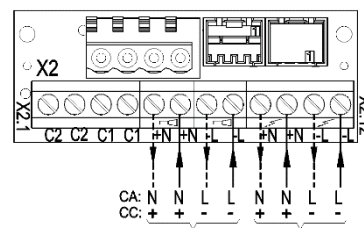
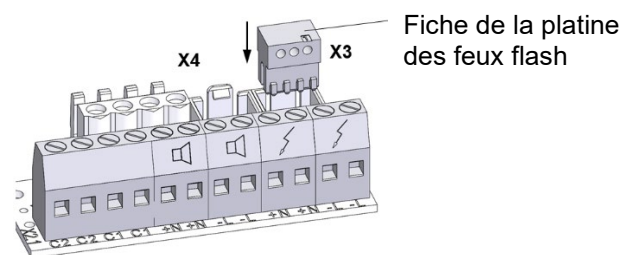

Raccordement de la tension de service pour la sirène

Raccordement de la tension de service pour les feux flash

7. Réglages du son (sur la platine pilote de la partie supérieure)

Le son souhaité peut être sélectionné à l'aide du commutateur de tonalité **S3** (sur la platine pilote de la partie supérieure). Les sons possibles sont décrits dans le tableau des sons en annexe.

Après l'application de la tension d'alimentation, un son est émis.

Version CC et version 48 C CA

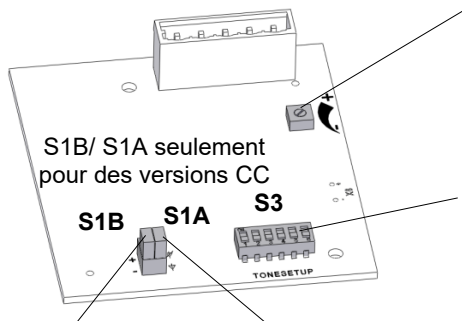

S1B (seulement CC) Sélection de la polarité de la tension de commande pour C1 et C2

S1A (seulement CC) Pontage de la diode de polarité

Réglage du volume sonore

Remarque :

Pour être conforme à la norme EN54-3, le dispositif de réglage du volume doit se trouver sur la position maximale.

Commutateur de tonalité **S3**

S1B S1A	Diode non pontée
+ <input type="checkbox"/> <input type="checkbox"/>	Polarité négative
- <input type="checkbox"/> <input type="checkbox"/>	Réglage d'usine
S1B S1A	Diode non pontée
+ <input type="checkbox"/> <input type="checkbox"/>	Polarité positive
- <input type="checkbox"/> <input type="checkbox"/>	
S1B S1A	Diode pontée
+ <input type="checkbox"/> <input type="checkbox"/>	Polarité négative
- <input type="checkbox"/> <input type="checkbox"/>	
S1B S1A	Diode pontée
+ <input type="checkbox"/> <input type="checkbox"/>	Polarité positive
- <input type="checkbox"/> <input type="checkbox"/>	

Version CA

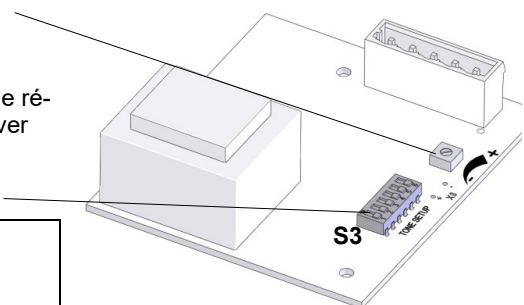

7.1 Modification des sons par activation externe

Pour les applications nécessitant d'autres sons que ceux de base, il est possible d'obtenir jusqu'à trois autres sons à l'aide des commandes électriques suivantes.

En principe, le son de base souhaité (J, voir le tableau des sons en annexe) est réglé en premier à l'aide du commutateur de tonalité S3 sur la platine pilote. Les sons supplémentaires correspondants (C1, C2, C1 + C2) figurent dans le tableau « Commande des sons » en annexe.

7.1.1 Sélections des sons par entrée de commande (TAS) – versions CA et CC

Version CC :

Remarque : La tension d'alimentation doit toujours être appliquée avec les entrées de commande.

Attention : Si la tension de commande est supérieure à la tension d'alimentation ou si la tension d'alimentation n'est pas appliquée, l'alimentation de service s'effectue par les entrées de commande. Une capacité de charge correspondante doit alors être assurée.

Commande négative : (réglage d'usine)

Positionner le commutateur comme suit :

- **S1A** sur ∇ (diode non pontée)
- Commutateur **S1B** sur « - »

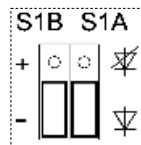

(sur la platine pilote)

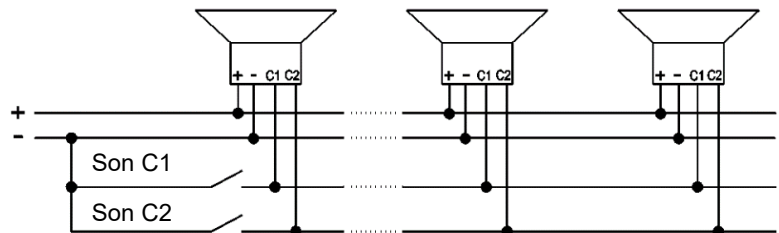
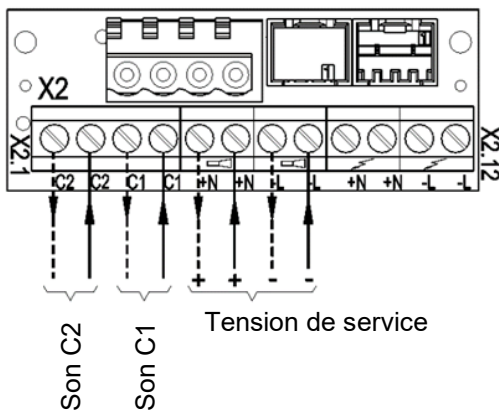

Commande positive :

Positionnez le commutateur comme suit :

- **S1A** sur ∇ (diode non pontée)
- Commutateur **S1B** sur « + » (commande positive)

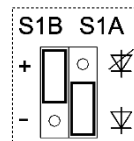

(sur la platine pilote)

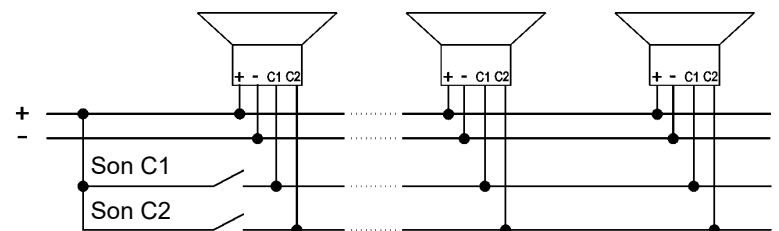
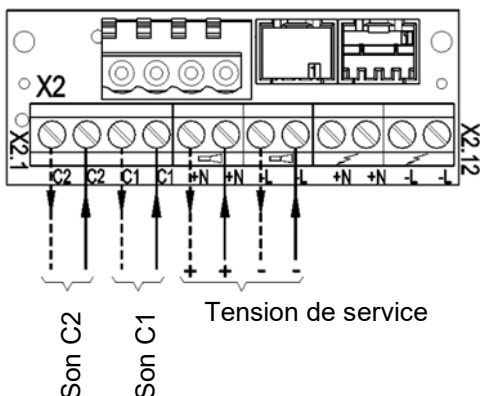

Version CA :

Remarque : La tension d'alimentation doit toujours être appliquée avec les entrées de commande.

24 V CA/ 115/ 230 V CA : La phase « L » de la tension d'alimentation s'effectue aux entrées de commande C1 ou C2.

Seulement 48 V CA: « N » de la tension d'alimentation s'effectue aux entrées de commande C1 ou C2.

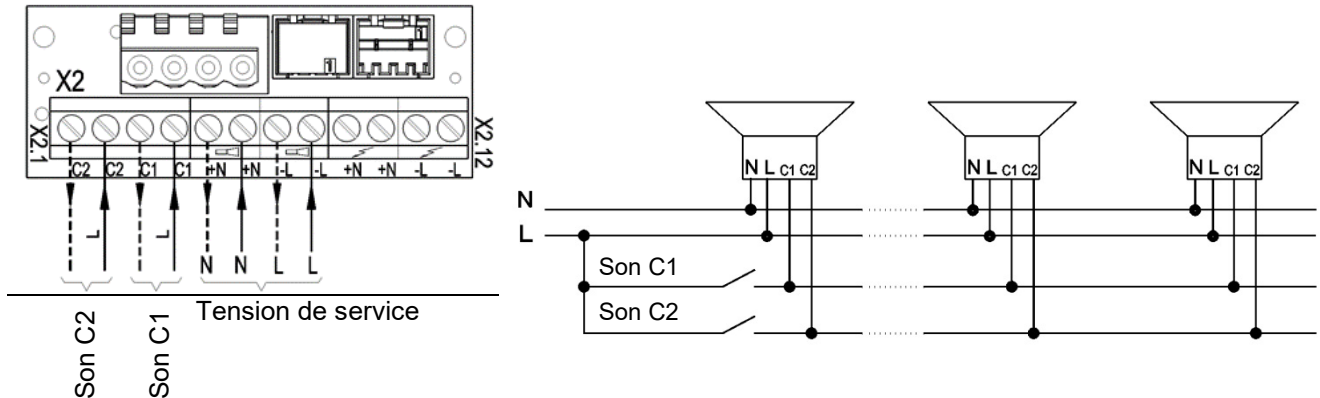
**7.1.2 Sélection des sons par l'entrée de commande (TAS) – pour toutes les versions CC**

Remarque : Valable uniquement pour la version CC !

La sirène peut être alimentée en courant de service par les entrées de commande C1 ou C2 sur la platine de raccordement. L'alimentation et la sélection des sons se font alors simultanément.

Positionnez le commutateur comme suit :

- **S1A** sur ∇ (diode non pontée)
- et commutateur **S1B** sur « + »

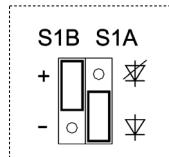

(sur la platine pilote)

- Branchez le pôle négatif à la platine de raccordement.
- Branchez le pôle positif à la platine de raccordement. Le son de base (♫) est émis.
- Le raccordement de la tension positive à C1 sur la platine de raccordement génère le son C1.
- Le raccordement de la tension positive à C2 sur la platine de raccordement génère le son C2.
- Le raccordement simultané de la tension positive à C1 et C2 sur la platine de raccordement génère le son « C1+C2 ».

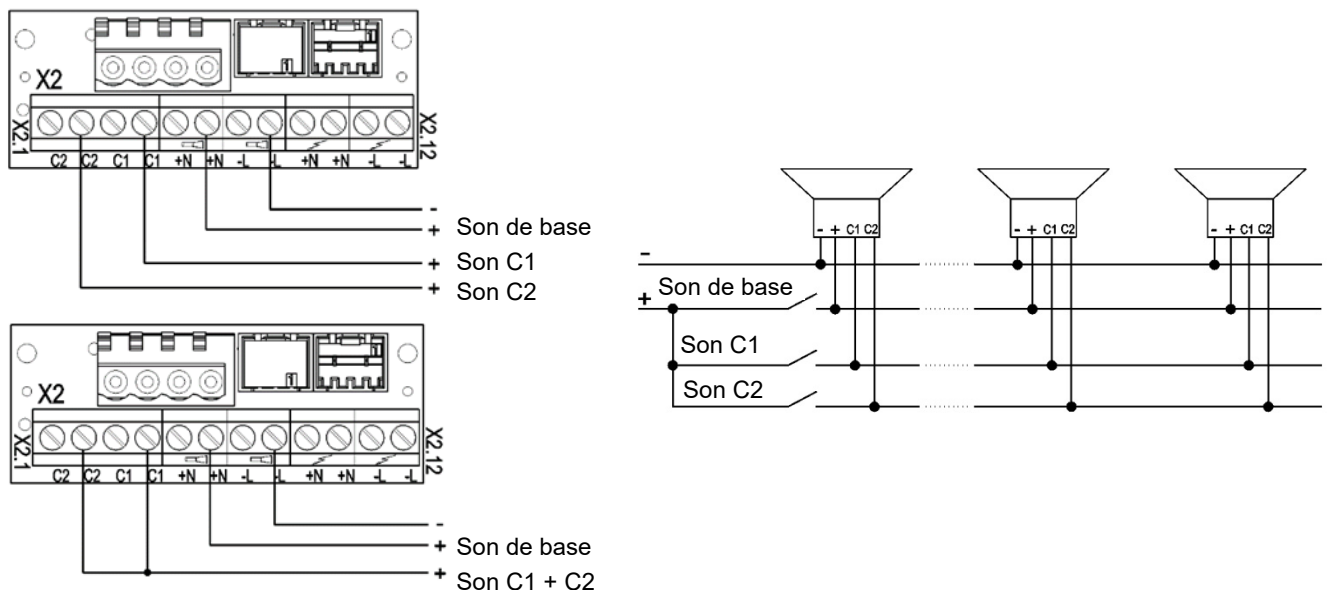

7.1.3 Sélection des sons par inversion de polarité (TAR) – pour toutes les versions CC (sauf appareils équipés de l'option –SSM)

Remarque : Valable uniquement pour la version CC !

N'utilisez pas ce système sur des appareils avec l'option –SSM !

Les entrées de commande C1 et C2 ne doivent pas être câblées sur la platine de raccordement !

Positionnez le commutateur comme suit :

- **S1A** sur  (diode pontée)
- et commutateur **S1B** sur « + »

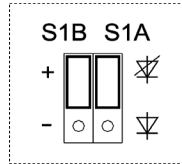

(sur la platine pilote)

En inversant polarité de la tension de service, il est possible de choisir, en plus du son de base, le son « C1 + C2 ».

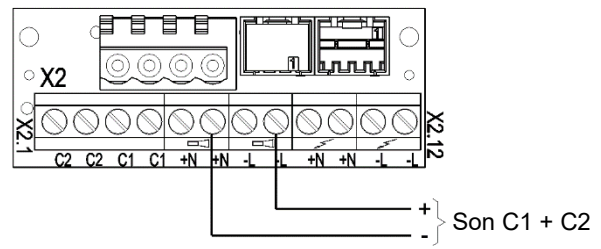
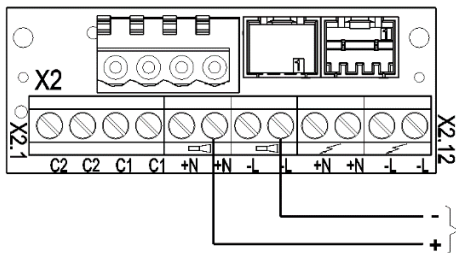

8. Option

–SSM (Module Soft-Start, uniquement 24 V CC)

La pointe du courant à l'enclenchement est limitée à :



Le transfert de la tension de service sur l'équipement s'effectue à partir de > 7 V.

Plage de tension de service : 18 V – 30 V CC

Positionnez la résistance (1kOhm) comme suit :

- Veillez à toujours installer la résistance pour la surveillance de ligne sur le dernier appareil.
- Pour les raccordements séparés du feu flash et de la sirène, voir ci-dessous pour la position de la deuxième résistance.
- Ôtez les résistances qui ne sont pas nécessaires.

Raccordement commun du feu flash et de la sirène :

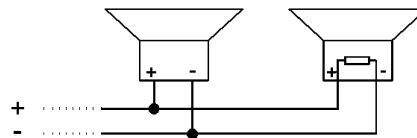
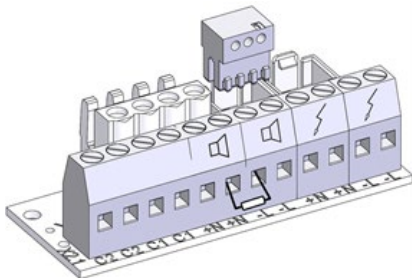

Raccordement séparé du feu flash et de la sirène :

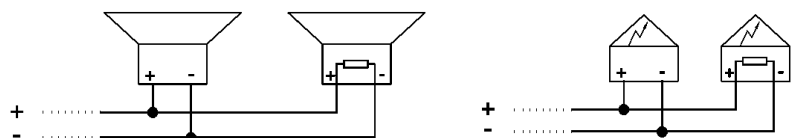
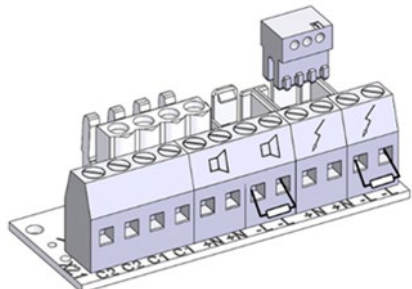

9. Accessoires

Numéro de l'article	Description
28300000002	Bouchon de plombier, lot de 4
28912000000	Boulons de verrouillage de rechange, lot de 4
28300000004	Étanchéité plane
28300000007	Kit PA 1 d'installation pour montage sur panneau

10. Maintenance, entretien, réparation

- Tenez compte des [Consignes de sécurité](#) pour toutes les interventions sur l'appareil.

L'appareil ne nécessite aucune maintenance particulière.

- Le nettoyage extérieur doit être effectué avec une solution légèrement savonneuse, sans solvant.
- Tous les composants doivent être remplacés uniquement par des pièces originales.
- Les réparations doivent en principe être effectuées dans les ateliers du fabricant.

Toute transformation, modification, utilisation incorrecte ou peu fiable ainsi que le non-respect des instructions de service entraînent une exclusion de la garantie.

11. Mise hors service, démontage et élimination

- Tenez compte des [Consignes de sécurité](#) pour toutes les interventions sur l'appareil.

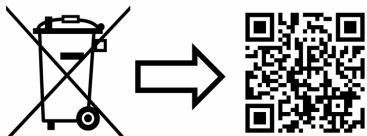

www.pfannenberg.com/disposal

Contenuto

Allegato “Tabella dei toni” e “Controllo dei toni”	1
1. Uso conforme	1
2. Scopo della fornitura	1
3. Dimensioni	2
4. Dati tecnici	2
4.1 Caratteristiche generali	2
4.2 Dati elettrici ca	3
4.3 Dati elettrici cc	3
5. Omologazioni	4
6. Messa in funzione	5
6.1 Istruzioni di sicurezza	5
6.2 Collegamento elettrico PA 1	6
6.3 Collegamento elettrico PA X 1-05	6
7. Impostazione dei toni (sulla scheda di controllo della parte superiore)	6
7.1 Cambio toni da controllo esterno	7
7.1.1 Selezione del livello dei toni attraverso l'ingresso di controllo (TAS), versioni ca e cc	7
7.1.2 Selezione del livello dei toni con l'alimentazione dall'ingresso di controllo (TAV), tutte le versioni cc	8
7.1.3 Selezione del livello dei toni attraverso inversione di polarità (TAR) - tutte le versioni cc (a eccezione di opzione –SSM)	9
8. Opzione	9
9. Accessori	10
10. Manutenzione, assistenza, riparazione	10
11. Messa fuori servizio, smontaggio e smaltimento	10
Allegato “Tabella dei toni” e “Controllo dei toni”	

1. Uso conforme

I segnalatori acustici della serie PA sono indicati per la segnalazione degli stati di pericolo in ambienti industriali, commerciali e negli edifici. L'uso della segnalazione acustica combinata alle luci flash (PA X 1-05) permette anche di sfruttare la segnalazione visiva.

I segnalatori acustici generano 80 diversi toni che è possibile selezionare attraverso l'interruttore interno. È possibile impostare un massimo di altri 3 toni attraverso il controllo esterno.

Utilizzare l'attrezzatura solo se non danneggiata e nel rispetto delle specifiche del cliente. Il funzionamento dell'attrezzatura è garantito solo se la parte superiore e quella inferiore sono montate in modo corretto.

L'attrezzatura è adatta all'impiego all'aperto e in ambienti chiusi, ma solo per il montaggio fisso.

2. Scopo della fornitura

La fornitura comprende:

N.1 segnalatore

N.1 membrana M20

N.1 guida rapida

N.1 resistenza (solo per versioni –SSM)

3. Dimensioni

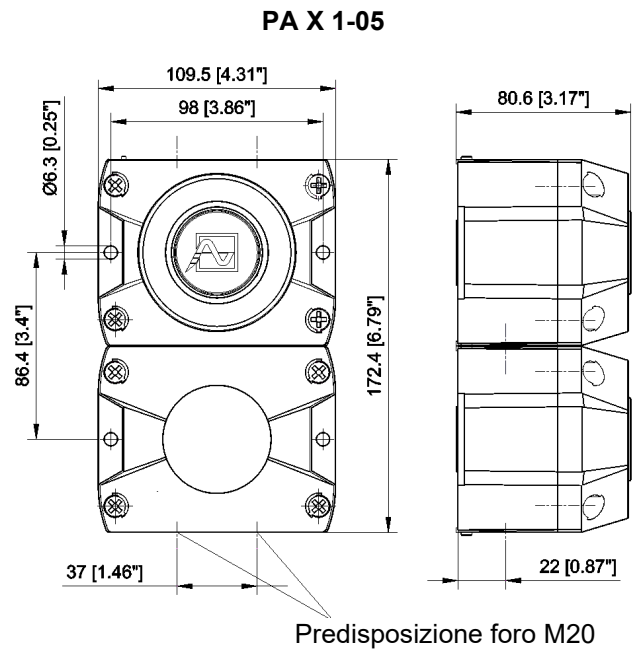
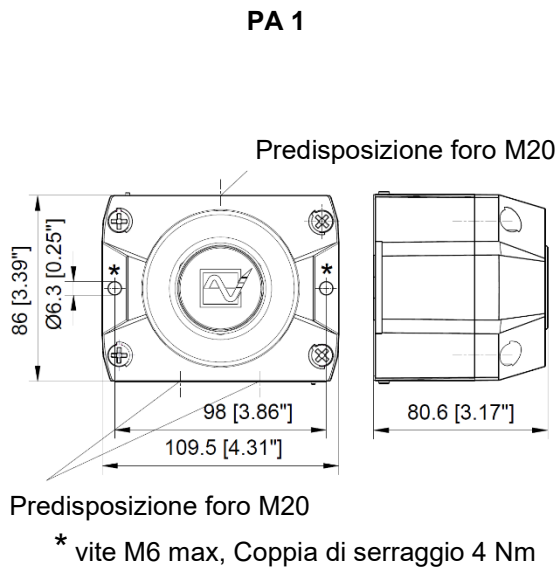

Schema forature interne all'alloggiamento (PA1)

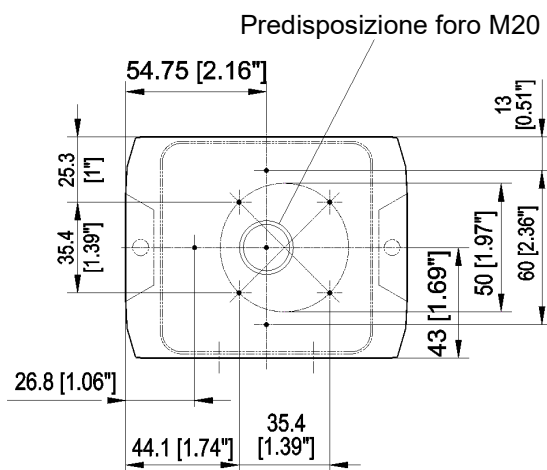

Schema forature interne all'alloggiamento (PA X 1-05)

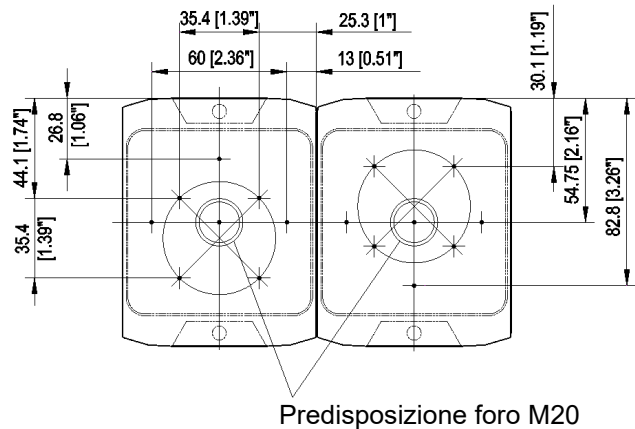

4. Dati tecnici

4.1 Caratteristiche generali

	PA 1	PA X 1-05
Pressione acustica max.	105 dB (A) 1m	
Regolazione del volume	max. -12dB	
Toni	80	
Energia flash	-	5 J
Frequenza flash	-	1 Hz
Fattore di servizio	100%	
Terminali di collegamento	0,14 - 2,5mm ² filo sottile / AWG24 - AWG 14	
Tipo di protezione	IP 66 (EN 60529), tipo 4 & 4x	
Resistenza agli urti	IK08 (EN 50102)	

Classe di protezione	II	
Temperatura d'esercizio	-40 °C...+55 °C	
Temperatura di stoccaggio	-40 °C...+70 °C	
Umidità rel. max.	90%	
Ingresso cavi	4x M20 preforati	5x M20 preforati
Area di tenuta degli occhiali	7 – 13 mm Se il diametro dei cavi è inferiore a 7 mm è necessario applicare un pressacavi con protezione adeguata.	
Materiale alloggiamento	PC/ ABS Blend	
Materiale calotta	PC	
Montaggio	A piacere	
Colori calotta	Trasparente, bianco, giallo, arancione, rosso, verde, blu	

4.2 Dati elettrici ca



	PA 1				PA X 1-05		
	24 V 50/60 Hz	48 V 50/60 Hz	115 V 50/60 Hz	230 V 50/60 Hz	24 V 50/60 Hz	115 V 50/60 Hz	230 V 50/60 Hz
Campo tensione nominale (per limitazioni v. omologazioni)	18 – 30 V	44 – 52 V	95 – 127 V	195–253 V	18 – 30V	95 – 127V	195 – 253V
Corrente assorbita segnalatore acustico (max)	150 mA	150 mA	30 mA	16 mA	150 mA	30 mA	16 mA
Corrente assorbita luce flash (max.)	-	-	-	-	800 mA	120 mA	90 mA
Potenza assorbita	4,5 VA	9 VA	4,5 VA	4,5 VA	34,5 VA	18,5 VA	25 VA

4.3 Dati elettrici cc

	PA 1		PA X 1-05		
	24 V oppure 12 – 48 V	120 V	12 V	24 V	48 V
Campo tensione nominale (per limitazioni v. omologazioni)	10 – 57 V	108 – 132 V	10 – 15 V	18 – 30 V	40 – 57 V
Corrente assorbita segnalatore acustico (max)	80 mA	30 mA	25 mA	70 mA	80 mA
Corrente assorbita luce flash (max.)	-	-	700 mA	360 mA	170 mA
Potenza assorbita	12 – 48 V: 4 W 24 V: 2 W	3,6 W	8 W	11,5 W	11,5 W

5. Omologazioni

(Le omologazioni sono valide per le attrezzature indicate)

Regolamento Prodotti da Costruzione (305/2011/UE)  12 0786 In corso :  22 0843	PA 1: DoP-No.: 03CPR2013-06-07 PA X 1-05: DoP-No.: 05CPR2013-06-07			
		PA 1	PA X 1-05	
	Opzioni	-SSM (24V cc)		
	Tensione nominale	24 – 48 V cc	24V cc	48V cc
	Campo di tensione in base a EN54-3, EN54-23	18 V – 57 V Opzione: -SSM (18 V – 30 V)	18 - 30V	40 - 57V
	Colore calotta luce flash	-	Rosso, trasparente	
	Tono	Conforme al Regolamento Prodotti da Costruzione (305/2011/UE) 1200Hz-500Hz (Dente di sega / Saw tooth) DIN/PFEER P.T.A.P. 500Hz-1200Hz (Tono ascendente / Slow whoop) 825Hz (Continuo / Continuous) 660Hz (Tono intermittente / Intermittent) 800Hz/ 1000Hz (Tono alternato / Alternating) 544Hz/ 440Hz (NF S 32-001)		
	2			
	15			
	60			
104				
131				
146				
Campo di segnalazione	EN54-3: v. documento 30303-005-1	EN 54-23 categoria O: v. documento 30303-005-1		
Classe di protezione ambientale	Tipo B			
Montaggio	A piacere	v. documento 30303-005-1		
La prova è stata condotta con l'utilizzo della membrana inclusa nella confezione e dei fori di fissaggio esterni.				
VdS	PA 1		PA X 1-05	
	G 212115		G 212188	
	Per i dati fare riferimento al Regolamento Prodotti da Costruzione (305/2011/UE)			
DNV	TAA00001R0			
MED	MEDB00002BH			
CNBOP	3558/2019		3560/2019	
UL, cUL	S7256 UCST, UCST7, ULSZ, ULSZ7, UEES, UEES7 (per ulteriori informazioni fare riferimento alle pagine 4-5 del capitolo in inglese)			

PA1, 48V CA: Senza omologazioni

6. Messa in funzione

6.1 Istruzioni di sicurezza

	<p>PERICOLO - Scosse elettriche letali Le parti sotto tensione e i cavi di collegamento liberi possono generare scosse elettriche causando gravi incidenti.</p> <ul style="list-style-type: none"> ➤ Solo personale autorizzato e con formazione in elettrotecnica è autorizzato a eseguire interventi sui collegamenti elettrici. ➤ Prima del montaggio togliere tensione a tutte le linee in ingresso e metterle in sicurezza in modo che non possano riattivarsi. Accertarsi sempre che non ci sia tensione. ➤ Attendere 5 minuti affinché i componenti elettrici siano privi di tensione. A quel punto sarà possibile aprire l'apparecchio. ➤ È possibile riattivare la tensione operativa solo con l'alloggiamento perfettamente chiuso.
	<p>AVVERTENZA - Pericolo per uso non conforme L'uso non conforme dell'apparecchio può causare gravi incidenti.</p> <ul style="list-style-type: none"> ➤ Durante l'installazione accertarsi che i cavi di collegamento non siano soggetti a trazione o torsione. <p>L'apparecchio è progettato per installazioni fisse. Per non compromettere la durata:</p> <ul style="list-style-type: none"> ➤ evitare il montaggio in ambienti polverosi o all'esterno con il megafono rivolto verso l'alto.
	<p>PERICOLO - Pericolo per danneggiamento dell'apparecchio L'inosservanza dei dati sulla targa del tipo può causare gravi incidenti.</p> <ul style="list-style-type: none"> ➤ Durante le operazioni di installazione e manutenzione dell'apparecchio rispettare sempre i dati riportati sulla targa del tipo.
	<p>ATTENZIONE - Pericolo di lesioni per bordi taglienti o parti calde</p> <ul style="list-style-type: none"> ➤ Eseguire le operazioni di installazione, montaggio, manutenzione o assistenza indossando i guanti. ➤ Eseguire i collegamenti lontano da bordi taglienti, spigoli o componenti interni.
	<p>ATTENZIONE - Compromissione delle capacità uditive ➤ Al fine di evitare una compromissione delle capacità uditive, indossare sempre un'adeguata protezione acustica nel corso delle operazioni/dei test.</p> <p>ATTENZIONE - Compromissione di vista Quando si combinano la segnalazione acustica alle luci flash:</p> <ul style="list-style-type: none"> ➤ per non compromettere la vista, evitare di rivolgere lo sguardo direttamente alla luce continua attiva.

Apertura dell'alloggiamento

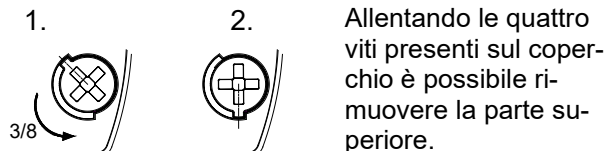

Chiusura dell'alloggiamento

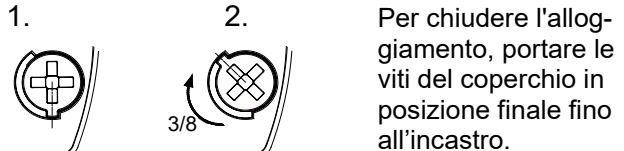

L'attrezzatura non viene fornita chiusa.

I sigilli di garanzia per le viti dell'alloggiamento sono disponibili come accessorio.

Ingressi dei cavi

La membrana compresa nella fornitura può essere sostituita da un pressacavo o da un connettore M12 con flangia M20.

- Montare solo pressacavi con protezione minima IP66 e nelle apposite aperture.
- Se il diametro del cavo è inferiore a 7 mm, usare un pressacavo con protezione adeguata.

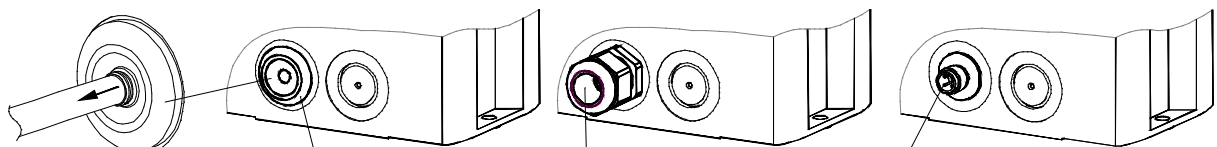

IP66 solo se la parte a imbuto della membrana è rivolta verso l'esterno.

Membrana IP66 (compresa)

Pressacavo IP 66 (Opzione)

Connettore M12 IP66, per attrezzature a bassissima tensione (Opzione)

Dopo aver montato il cavo, togliere i residui della membrana.

6.2 Collegamento elettrico PA 1

Scheda nella parte inferiore:

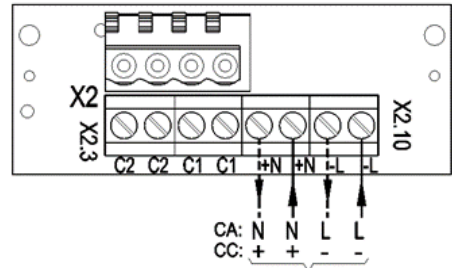
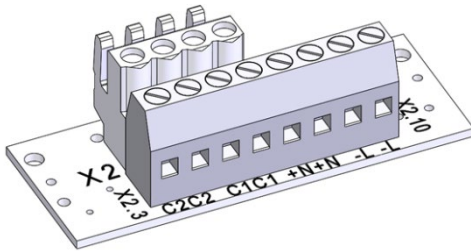

Collegamento tensione operativa

6.3 Collegamento elettrico PA X 1-05

Collegamento congiunto di luci flash e segnalazione acustica (Impostazione di fabbrica)

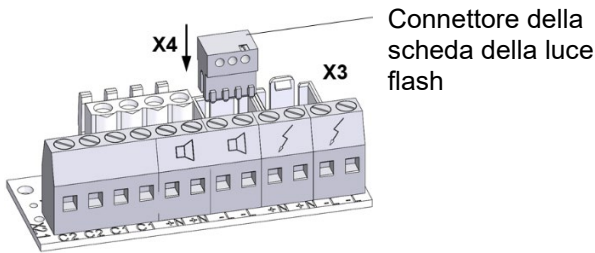

Connettore della scheda della luce flash

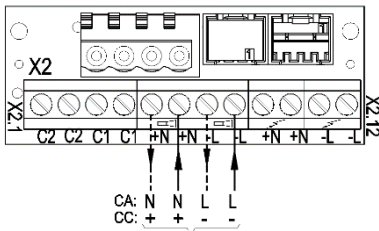

Collegamento tensione operativa

Collegamento separato di luci flash e segnalazione acustica

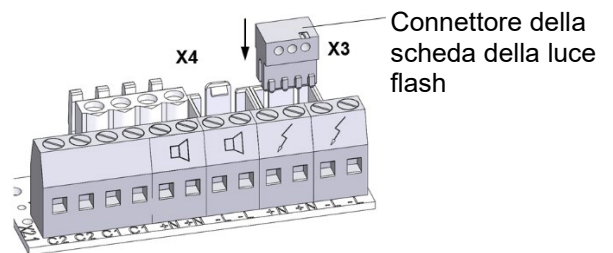

Connettore della scheda della luce flash

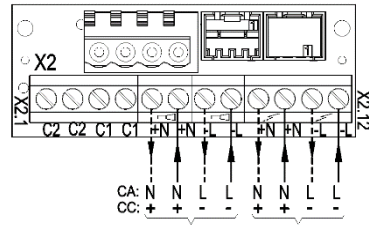

Collegamento tensione operativa per segnalatore acustico

Collegamento tensione operativa per luce flash

7. Impostazione dei toni (sulla scheda di controllo della parte superiore)

È possibile selezionare il tono desiderato mediante l'apposito interruttore **S3** (sulla scheda di controllo della parte superiore). I possibili toni sono descritti nella tabella allegata. Il tono viene emesso una volta attivata la tensione di alimentazione.

Versione cc e 48 V ca

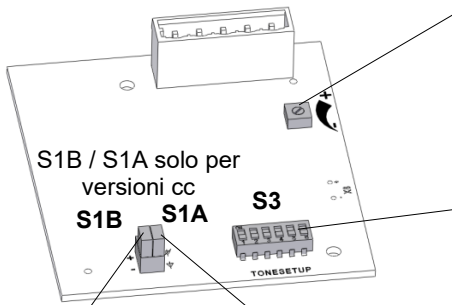

S1B (solo versioni cc) Selezione della polarità della tensione di comando per C1 e C2
S1A (solo versioni cc) Bypass del diodo di protezione contro l'inversione di polarità

Regolazione volume

Nota:
al fine di garantire la conformità alla norma EN54-3, la regolazione del volume deve essere impostata sul massimo.

Selettore toni **S3**

S1B S1A + -	Diode non bypassato Polarità negativa Impostazione di fabbrica
S1B S1A + -	Diode non bypassato Polarità positiva
S1B S1A + -	Diode bypassato Polarità negativa
S1B S1A + -	Diode bypassato Polarità positiva

Versione ca

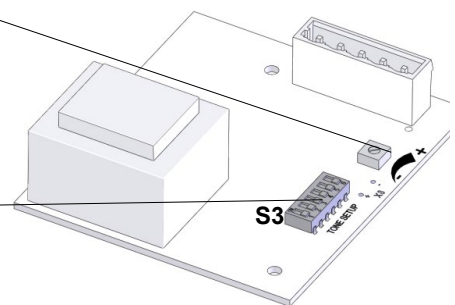

7.1 Cambio toni da controllo esterno

Per le applicazioni che oltre al tono base necessitano anche di altri toni, è possibile impostarne fino a un massimo di altri tre attraverso il controllo elettrico descritto di seguito.

Il tono base desiderato viene impostato con il selettore toni S3 sulla scheda di controllo (v. allegato tabella toni). Gli altri toni corrispondenti (C1, C2, C1+C2) devono essere scelti da quelli contenuti nella tabella allegata "Controllo dei toni".

7.1.1 Selezione del livello dei toni attraverso l'ingresso di controllo (TAS), versioni ca e cc

Versione cc:

Nota: attivare sempre la tensione di alimentazione insieme agli ingressi di controllo.

Attenzione: se la tensione di comando è maggiore rispetto a quella di alimentazione oppure se la tensione di alimentazione è assente, l'alimentazione elettrica passa per gli ingressi di controllo. In tal caso è necessario garantire che il carico sia ammissibile.

Controllo negativo: (impostazione di fabbrica)

Impostare l'interruttore come indicato di seguito:

- **S1A** su ∇ (diodo non bypassato)
- Commutatore **S1B** su "-"

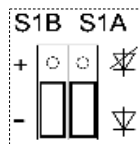

(sulla scheda di controllo)

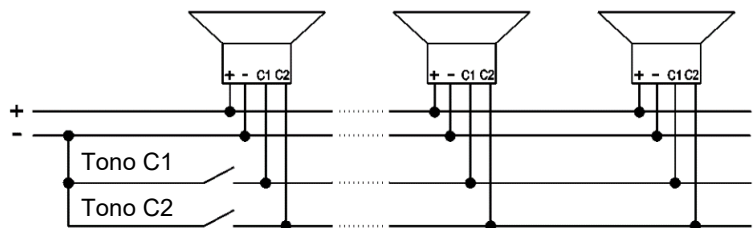
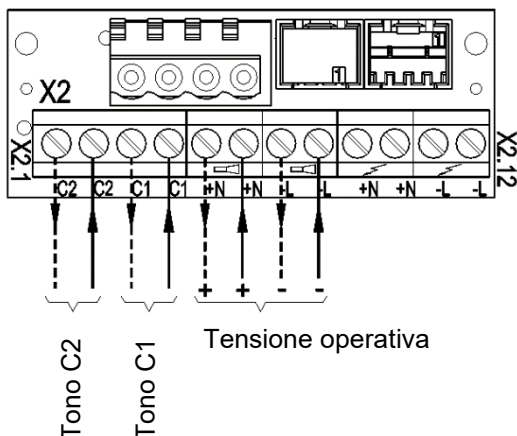

Controllo positivo:

Impostare l'interruttore come indicato di seguito:

- **S1A** su ∇ (diodo non bypassato)
- commutatore **S1B** su "+" (controllo positivo)

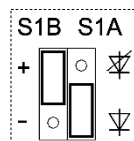

(sulla scheda di controllo)

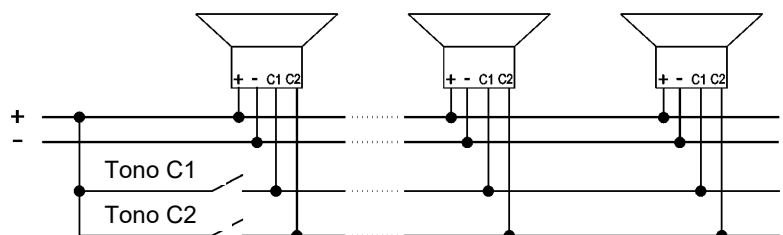
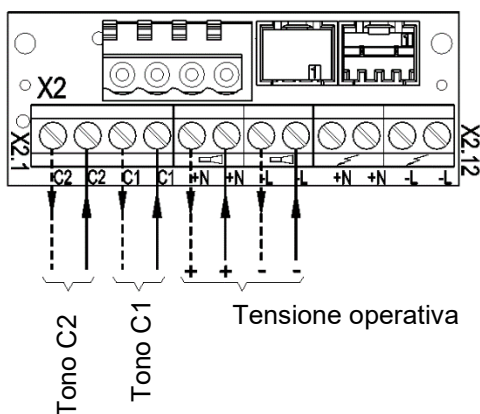

Versione ca:

Nota: attivare sempre la tensione di alimentazione insieme agli ingressi di controllo.

24 V CA/ 115/ 230 V CA: Attivare la fase **L** della tensione di alimentazione agli ingressi di controllo C1 o C2.

48 V CA: Attivare **N** della tensione di alimentazione agli ingressi di controllo C1 o C2.

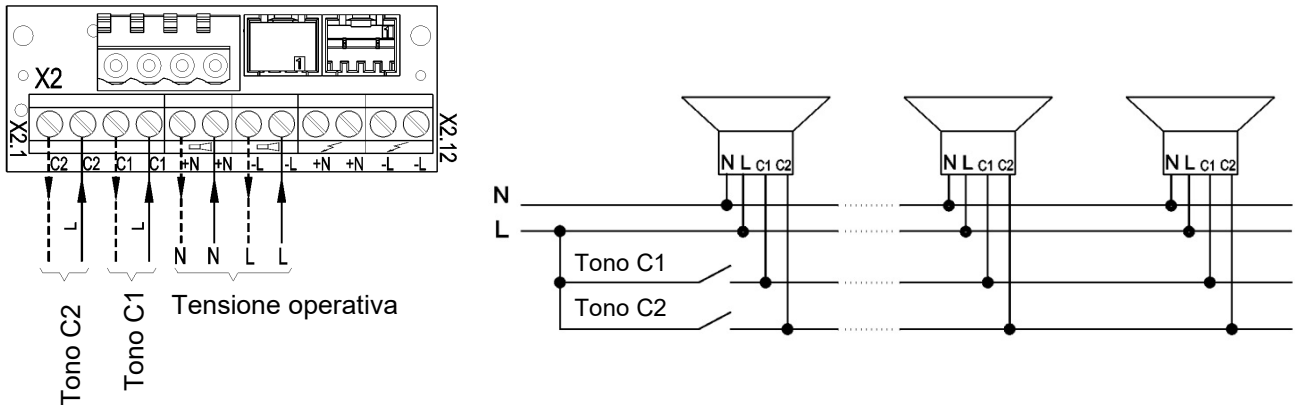

7.1.2 Selezione del livello dei toni con l'alimentazione dall'ingresso di controllo (TAV), tutte le versioni cc

Nota: usare solo con le versioni cc!

Il segnalatore acustico può essere alimentato dagli ingressi di controllo C1 o C2 della scheda di collegamento con tensione operativa. Alimentazione e selezione dei toni avvengono quindi in contemporanea.

Impostare l'interruttore come indicato di seguito

- **S1A** su ∇ (diodo non bypassato)
- commutatore **S1B** su "+"

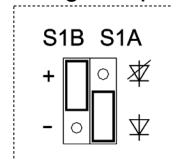

(sulla scheda di controllo)

- Collegare il polo negativo sulla scheda di collegamento.
- Collegare il polo positivo sulla scheda di collegamento. Viene prodotto il tono base (♯).
- Collegando la tensione positiva a C1 sulla scheda di collegamento viene prodotto il tono C1.
- Collegando la tensione positiva a C2 sulla scheda di collegamento viene prodotto il tono C2.
- Collegando contemporaneamente la tensione positiva a C1 e C2 sulla scheda di collegamento viene prodotto il tono C1+C2.

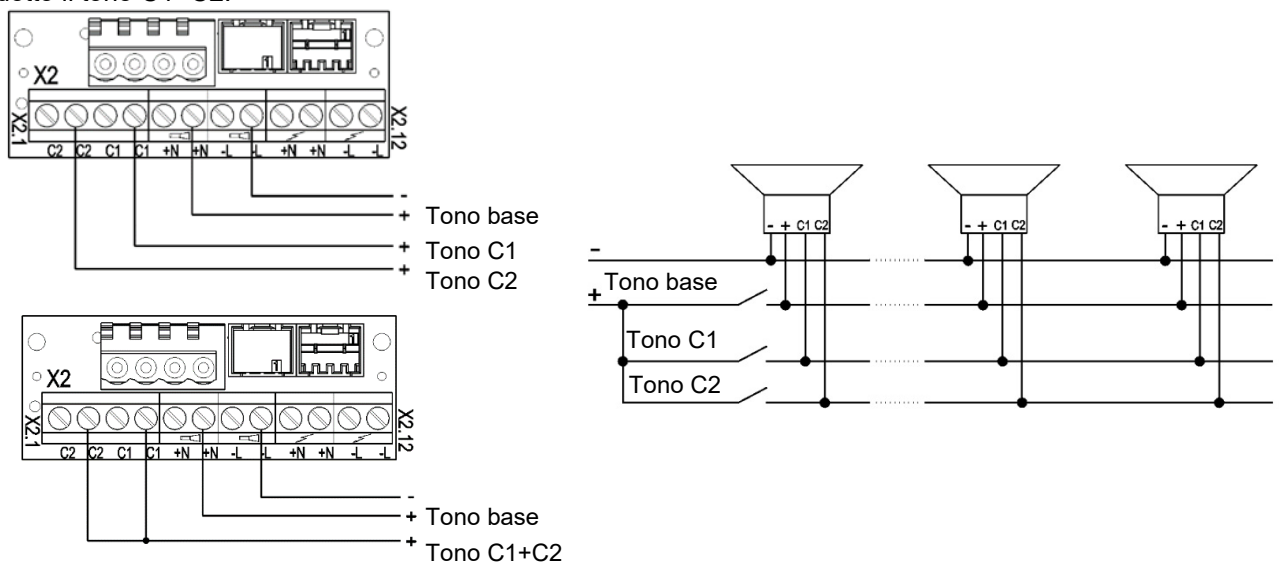

7.1.3 Selezione del livello dei toni attraverso inversione di polarità (TAR) - tutte le versioni cc (a eccezione di opzione -SSM)

Nota: usare solo con le versioni cc!

Non usare con le versioni -SSM!

Non collegare gli ingressi di controllo C1 e C2 sulla scheda di collegamento!

Impostare l'interruttore come indicato di seguito

- **S1A** su ∇ (diodo bypassato)
- e commutatore **S1B** su "+"

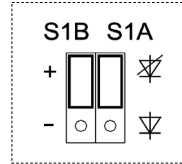

(sulla scheda di controllo)

Con l'inversione di polarità della tensione operativa al tono base (♯) è possibile selezionare anche "C1+C2":

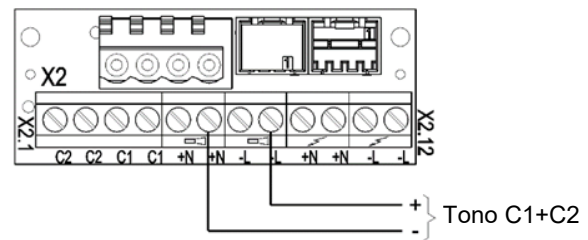
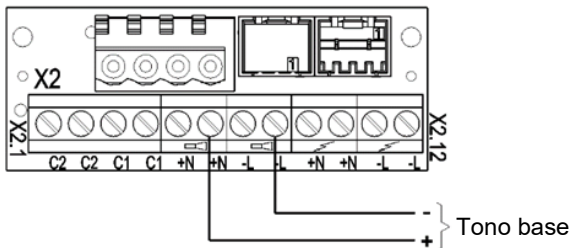

8. Opzione

-SSM (Soft Start Module, solo 24V cc)

Il picco di corrente di spunto viene limitato a:



La tensione operativa viene portata al componente solo a partire da >7 V.

Campo di tensione operativa: 18 V – 30 V cc

Posizionamento della resistenza (1 kOhm):

- La resistenza di monitoraggio della linea deve essere montata sull'ultimo apparecchio.
- Se il segnalatore acustico e le luci flash sono separati, posizionare la seconda resistenza come indicato sotto.
- Togliere le resistenze non necessarie.

Collegamento di segnalatore acustico e luce flash uniti:

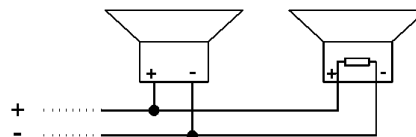
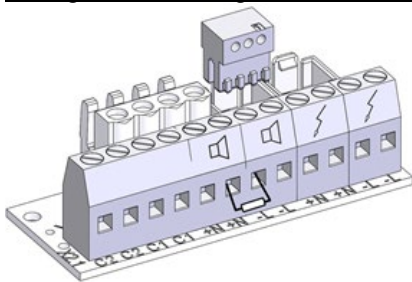

Collegamento di segnalatore acustico e luce flash separati:

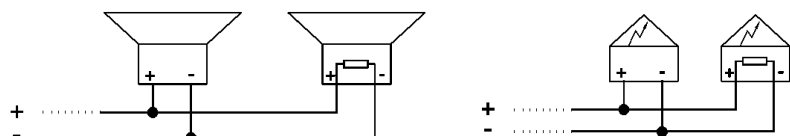
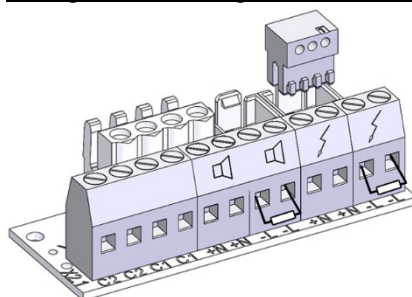

9. Accessori

N. art.	Descrizione
28300000002	Sigilli di garanzia, confezione da 4
28912000000	Perni di blocco di ricambio, confezione da 4
28300000004	Guarnizione superficiale
28300000007	Kit PA 1 per montaggio a incasso

10. Manutenzione, assistenza, riparazione

- Quando si eseguono interventi sull'apparecchio rispettare le [Istruzioni di sicurezza](#).

L'apparecchio non richiede una particolare manutenzione.

- Pulire le parti esterne con una soluzione detergente delicata senza usare solventi.
- Sostituire i componenti con ricambi originali.
- Fare eseguire le riparazioni solo presso il fabbricante.

Interventi, modifiche, usi errati e non consentiti insieme al mancato rispetto delle istruzioni contenute nel presente manuale d'uso rendono nulla la garanzia.

11. Messa fuori servizio, smontaggio e smaltimento

- Quando si eseguono interventi sull'apparecchio rispettare le [Istruzioni di sicurezza](#).

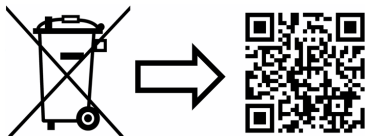

www.pfannenber.com/disposal

Содержание

1. Применение по назначению	1
2. Объем поставки	1
3. Габаритные размеры	2
4. Технические характеристики	2
4.1 Общая информация.....	2
4.2 Электрические параметры, версия переменного тока	3
4.3 Электрические параметры, версия постоянного тока	3
5. Разрешения	4
6. Ввод в эксплуатацию	5
6.1 Указания по технике безопасности.....	5
6.2 Подключение к электросети РА 1	6
6.3 Подключение к электросети РА X 1-05.....	6
7. Настройки звукового тона (на плате драйвера в верхней части)	6
7.1 Изменение звуковых тонов с помощью внешнего управления.....	7
7.1.1 Выбор уровня звукового тона по управляющему входу (TAS), версии переменного и постоянного тока	7
7.1.2 Выбор уровня звукового тона по управляющему входу (TAV), все версии постоянного тока	8
7.1.3 Выбор уровня звукового тона путем инверсии полярности (TAR), все версии постоянного тока (кроме опции –SSM).....	9
8. Опция	9
9. Дополнительное оборудование	10
10. Уход, сервис, техническое обслуживание	10
11. Вывод из эксплуатации, демонтаж и утилизация	10
Приложение „Таблица звуковых тонов“ и „Управление звуко-выми тонами“	

Принимать во внимание защитные надписи в соответствии с DIN ISO 16016!

Русский перевод

1. Применение по назначению

Излучатели звука серии РА предназначены для сигнализации, например, опасных состояний в промышленности, торговле и строительстве. При использовании комбинации излучателя звука и лампы-вспышки (РА X 1-05) существует дополнительная возможность оптической сигнализации.

Излучатели звука воспроизводят акустические сигналы 80 различных звуковых тонов, которые можно выбирать с помощью внутреннего переключателя. Имеется возможность с помощью внешнего управления переключаться еще на макс. 3 звуковых тона.

Эксплуатировать устройства только в неповрежденном состоянии в пределах указанных параметров. Функционирование устройства гарантируется только при правильной сборке верхней и нижней частей. Устройства предусмотрены для применения внутри и вне помещений и предназначены только для стационарного монтажа.

2. Объем поставки

Объем поставки состоит из:

- 1x сигнальное устройство
- 1x мембранный ниппель M20
- 1x краткое руководство
- 1x сопротивление (только в версиях –SSM)

3. Габаритные размеры

PA 1

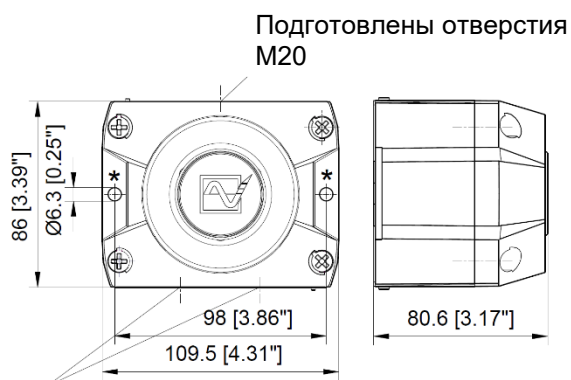

Подготовлены отверстия M20

* Макс. винт M6, Момент затяжки 4 Нм

Схема расположения отверстий внутри корпуса (PA 1)



PA X 1-05

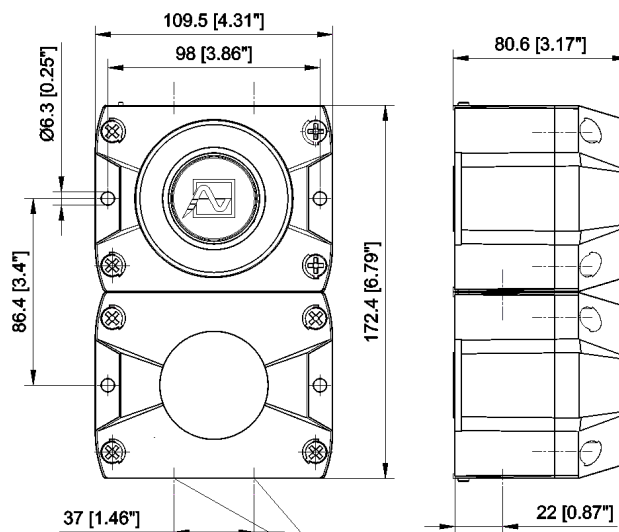

Подготовлены отверстия M20

Схема расположения отверстий внутри корпуса (PA X 1-05)

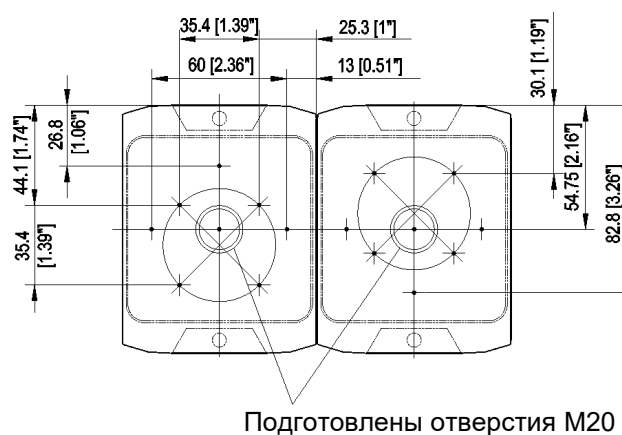

4. Технические характеристики

4.1 Общая информация

	PA 1	PA X 1-05
Макс. уровень звука	105 дБ (A) 1 м	
Регулировка громкости	макс. -12 дБ	
Звуковые тоны	80	
Энергия вспышки	-	5 Дж
Частота вспышек	-	1 Гц
Продолжительность включения	100%	
Соединительные зажимы	0,14 - 2,5 мм ² тонкопроволочные / AWG24 - AWG 14	
Род защиты	IP 66 (EN 60529), тип 4 и 4х	
Ударная прочность	IK08 (EN 50102)	

Класс защиты	II	
Рабочая температура	-40 °C/ +55 °C	
Температура хранения	-40 °C/ +70 °C	
Макс. отн. влажность воздуха	90%	
Кабельный ввод	4x M20 выполнены	5x M20 выполнены
Зона уплотнения проходной втулки	7 – 13 мм при использовании кабелей диаметром < 7 мм предусмотреть кабельный ввод с достаточной степенью защиты	
Материал корпуса	сплав полимеров PC/ ABS	
Материал кожуха	PC	
Монтажное положение	любое	
Цвета колпака	прозрачный, белый, желтый, оранжевый, красный, зеленый, синий	

4.2 Электрические параметры, версия переменного тока



	РА 1				РА X 1-05		
	24 В 50/60 Гц	48 В 50/60 Гц	115 В 50/60 Гц	230 В 50/60 Гц	24 В 50/60 Гц	115 В 50/60 Гц	230 В 50/60 Гц
Номинальное напряжение (ограничения смотри разрешения)	24 В 50/60 Гц	48 В 50/60 Гц	115 В 50/60 Гц	230 В 50/60 Гц	24 В 50/60 Гц	115 В 50/60 Гц	230 В 50/60 Гц
Диапазон напряжений	18 – 30 В	44 – 52 В	95 – 127 В	195 – 253 В	18 – 30 В	95 – 127 В	195 – 253 В
Потребляемый ток излучателя звука (макс.)	150 мА	150 мА	30 мА	16 мА	150 мА	30 мА	16 мА
Потребляемый ток лампы-вспышки (макс.)	-	-	-	-	800 мА	120 мА	90 мА
Потребляемая мощность	4,5 ВА	9 ВА	4,5 ВА	4,5 ВА	34,5 ВА	18,5 ВА	25 ВА

4.3 Электрические параметры, версия постоянного тока

	РА 1		РА X 1-05		
	24 В или 12 - 48 В	120 В	12 В	24 В	48 В
Номинальное напряжение (ограничения смотри разрешения)	24 В или 12 - 48 В	120 В	12 В	24 В	48 В
Диапазон напряжений	10 – 57 В	108 – 132 В	10 – 15 В	18 – 30 В	40 – 57 В
Потребляемый ток излучателя звука (макс.)	80 мА	30 мА	25 мА	70 мА	80 мА
Потребляемый ток лампы-вспышки (макс.)	-		700 мА	360 мА	170 мА
Потребляемая мощность	12 - 48 В: 4 Вт 24 В: 2 Вт	3,6 Вт	8 Вт	11,5 Вт	11,5 Вт

5. Разрешения



(Разрешения действительны для отмеченных устройств)

<p>Регламент на строительные изделия (305/2011/EU)</p>  <p>На стадии подготовки:</p> 	<p>PA 1: DoP-№.: 03CPR2013-06-07 PA X 1-05: DoP-№.: 05CPR2013-06-07</p>				
		PA 1		PA X 1-05	
	Опции	-SSM (24 В пост. тока)			
	Номинальное напряжение	24 – 48 В пост. тока		24 В пост. тока	48 В пост. тока
	Диапазон напряжений в соответствии с EN54-3, EN54-23	18 В – 57 В Опция: -SSM (18 В – 30 В)		18 - 30 В	40 - 57 В
	Цвет колпака лампы-вспышки	-		красный, прозрачный	
	Звуковой тон	Регламент на строительные изделия (305/2011/EU)			
	2	1200 Гц - 500 Гц (пилообразный/ Saw tooth) DIN/PFEER P.T.A.P.			
	15	500 Гц - 1200 Гц (повышающийся тон/ Slow whoop)			
	60	825 Гц (постоянный тон/ Continuous)			
104	660 Гц (прерывистый тон/ Intermittent)				
131	800 Гц/ 1000 Гц (переменный тон/ Alternating)				
146	544 Гц/ 440 Гц (NF S 32-001)				
Диапазон сигнализации	EN54-3: смотри документ 30303-005-1		EN 54-23 Категория O: смотри документ 30303-005-1		
Класс экологичности	Тип B				
Монтажное положение	любое		смотри документ 30303-005-1		
Проверка осуществлялась с применением входящего в комплект поставки мембранного ниппеля и наружных крепежных отверстий.					
VdS (Союз страховщиков имущества)	PA 1		PA X 1-05		
	G 212115		G 212188		
	Данные - см. Регламент на строительные изделия (305/2011/EU)				
DNV	TAA00001R0				
MED	MEDB00002BH				
CNBOP	3558/2019		3560/2019		
UL, cUL	<p>S7256 UCST, UCST7, ULSZ, ULSZ7, UEES, UEES7 (более подробную информацию см. страницу 4 - 5 в англоязычной главе)</p>				

PA 1, 48 В перем. тока: Без разрешений

6. Ввод в эксплуатацию

6.1 Указания по технике безопасности

	<p>ОПАСНОСТЬ - Опасность для жизни в результате поражения электрическим током Находящиеся под напряжением устройства и открытые соединительные линии создают опасность поражения электрическим током и могут вызывать тяжелые несчастные случаи.</p> <ul style="list-style-type: none"> ➤ Работы над подключениями к электросети разрешается выполнять только обученным и авторизованным специалистам-электрикам. ➤ Перед монтажом все подводящие линии необходимо обесточить и заблокировать от повторного включения. Обязательно обеспечить отсутствие напряжения. ➤ Выждать фазу разряда в 5 минут для электрических компонентов. Лишь затем открывать устройство. ➤ Включение рабочего напряжения должно производиться только на плотно закрытом корпусе.
	<p>ПРЕДУПРЕЖДЕНИЕ - Опасность в результате недопустимого применения устройств Применение не по назначению может привести к тяжелым авариям.</p> <ul style="list-style-type: none"> ➤ Во время монтажа следить за тем, чтобы соединительный кабель был защищен от растяжения и перекручивания. <p>Устройства предназначены исключительно для стационарного монтажа. Для обеспечения длительного функционирования:</p> <ul style="list-style-type: none"> ➤ не устанавливайте рупор в пыльном окружении или на открытом месте направленным вверх.
	<p>ОПАСНОСТЬ - Опасность в результате повреждения устройств Несоблюдение данных заводской таблички может привести к тяжелым авариям.</p> <ul style="list-style-type: none"> ➤ При установке и техническом обслуживании устройств всегда учитывать данные на заводской табличке.
	<p>ВНИМАНИЕ - Опасность травмирования острыми кромками или горячими деталями</p> <ul style="list-style-type: none"> ➤ Во время работ по установке, монтажу или техническому обслуживанию носить перчатки. ➤ Разводку кабелей выполнять вдали от острых кромок, углов и внутренних компонентов.
	<p>ВНИМАНИЕ - Опасность ухудшения слуха</p> <ul style="list-style-type: none"> ➤ Чтобы предотвратить ухудшение слуха, используйте средства защиты от шума во время работы / тестирования. <p>ВНИМАНИЕ - Опасность ухудшения зрения При использовании комбинации излучателя звука и лампы-вспышки:</p> <ul style="list-style-type: none"> ➤ Чтобы не допустить ухудшения зрения, избегать длительного прямого зрительного контакта с включенной лампой.

Открытие корпуса



Закрытие корпуса

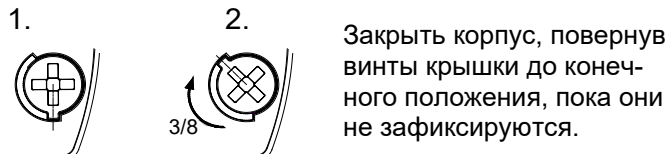

Устройство поставляется в незакрытом состоянии.

Заткунки для пломбирования винтов корпуса можно приобрести в виде дополнительного оборудования.

Кабельные вводы

Входящий в комплект поставки мембранный ниппель можно заменить кабельным вводом или штекерным соединителем M12 с размером фланца M20.

- Монтировать только кабельные вводы со степенью защиты минимум IP66 в соответствующих отверстиях.

В случае кабелей диаметром < 7 мм использовать кабельный ввод с достаточной степенью защиты.

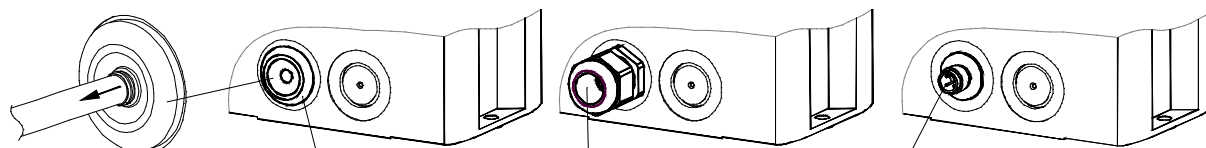

IP 66 только с воронкой мембраны, обращенной наружу. После монтажа кабеля удалить остатки мембраны.

Мембранный ниппель IP 66 (Входит в комплект поставки)

Кабельный ввод IP 66 (Опция)

Штекерный соединитель M12 IP 66 (Для низковольтных устройств, Опция)

6.2 Подключение к электросети РА 1

Панель в нижней части:

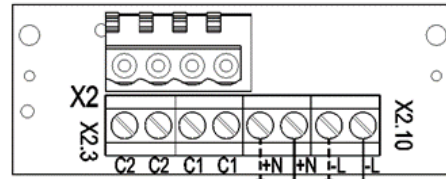
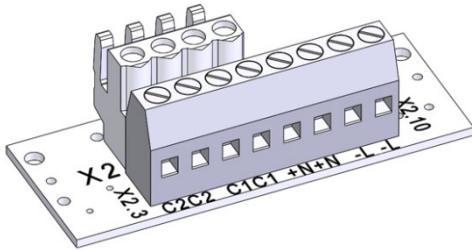

Переменный ток: N N L L
 Постоянный ток: + + - -
 Подключение рабочего напряжения

6.3 Подключение к электросети РА X 1-05

Совместное подключение лампы-вспышки и излучателя звука (Заводская установка)

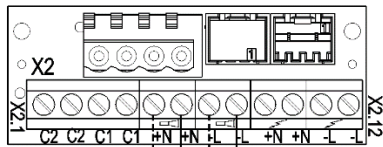
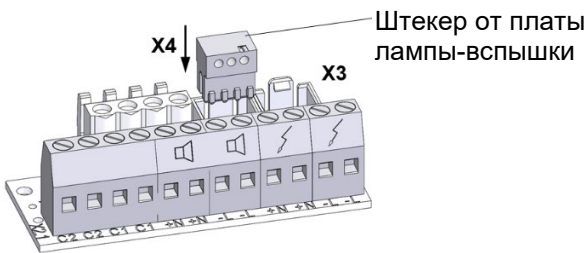

Переменный ток: N N L L
 Постоянный ток: + + - -
 Подключение рабочего напряжения

Раздельное подключение лампы-вспышки и излучателя звука

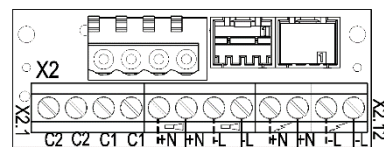
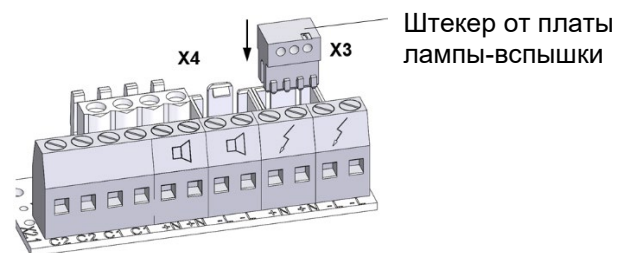

Переменный ток: N N L L N N L L
 Постоянный ток: + + - - + + - -
 Подключение рабочего напряжения для излучателя звука Подключение рабочего напряжения для лампы-вспышки

7. Настройки звукового тона (на плате драйвера в верхней части)

Требуемый звуковой тон выбирается с помощью переключателя звуковых тонов **S3** (на плате драйвера в верхней части). Возможные звуковые тоны описаны в таблице звуковых тонов в приложении. После подачи напряжения питания генерируется звуковой тон.

Версия пост. Тока + 48 В перем. тока

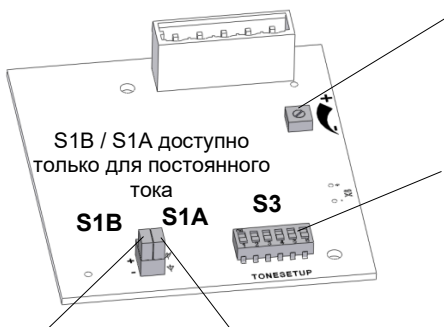

S1B (только Постоянный ток)
 Выбор полярности управляющего напряжения для C1 и C2

S1A (только Постоянный ток)
 Перемыкание диода инверсии полярности

Регулятор громкости
 Указание:
 Для соответствия EN54-3 регулятор громкости должен находиться в максимальном положении.

Переключатель звуковых тонов **S3**

S1B S1A + - - -	Диод не переключен Полярность отрицательная Заводская установка
S1B S1A + - - -	Диод не переключен Полярность положительная
S1B S1A + - + -	Диод переключен Полярность отрицательная
S1B S1A + - + -	Диод переключен Полярность положительная

Версия перем. тока

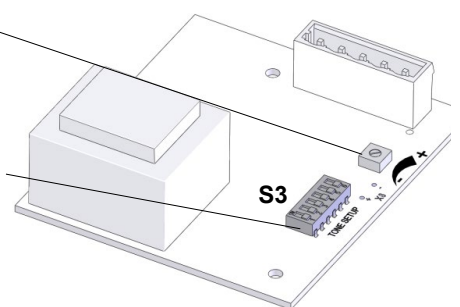

7.1 Изменение звуковых тонов с помощью внешнего управления

Для применений, где в дополнение к базовому тону требуются дополнительные звуковые тоны, имеется возможность добавить еще до трех других тонов, используя следующие электрические элементы управления.

Желаемый основной тон (J, см. таблицу звуковых тонов в приложении) устанавливается сначала с помощью переключателя звуковых тонов S3 на плате драйвера. Соответствующие дополнительные звуковые тоны (C1, C2, C1+C2) можно найти в таблице „Управление тонами“ в приложении.

7.1.1 Выбор уровня звукового тона по управляющему входу (TAS), версии переменного и постоянного тока

Версия пост. тока:

Указание: Напряжение питания подавать всегда вместе с управляющими входами.

Внимание: Если управляющее напряжение больше, чем напряжение питания, или напряжение питания не подается, то рабочее токоснабжение осуществляется через управляющие входы. В таком случае должна обеспечиваться соответствующая допустимая нагрузка.

Отрицательный управление: (Заводская установка)

Выполнить перемещение переключателя в следующее положение:

- S1A на ∇ (диод не перемкнут)
- Переключатель S1B на „-“

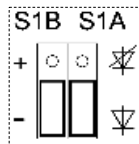

(на плате драйвера)

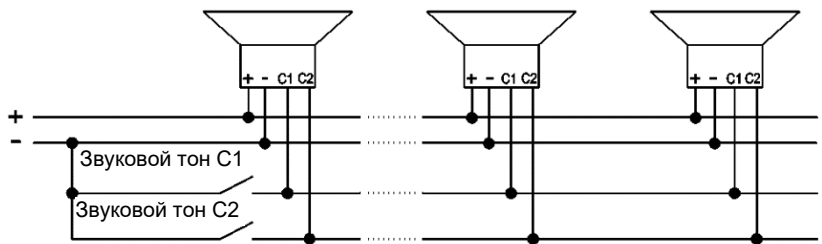
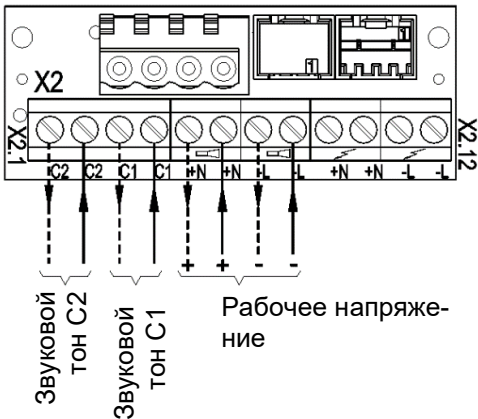

Положительное управление:

Выполнить перемещение переключателя в следующее положение:

- S1A на ∇ (диод не перемкнут)
- Переключатель S1B на „+“ (положительное управление)

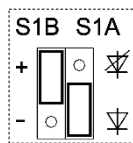

(на плате драйвера)

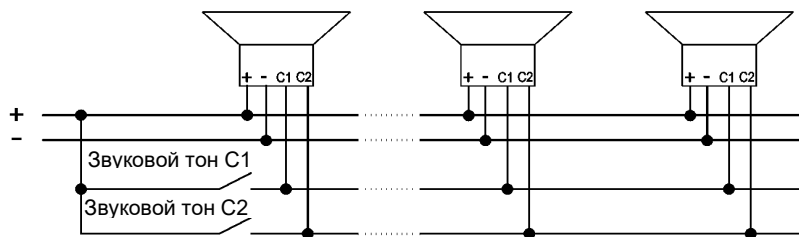
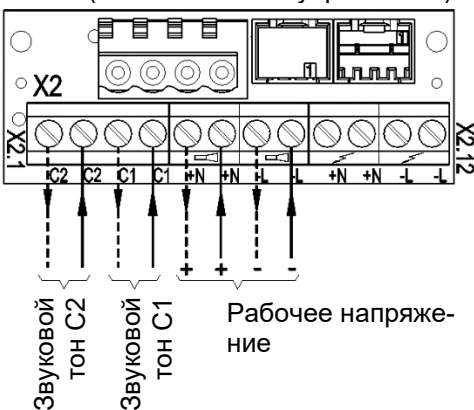

Версия перем. тока:

Указание: Напряжение питания подавать всегда вместе с управляющими входами.

24 V перем. тока / 115/ 230 V перем. тока : Подать фазу "L" напряжения питания на управляющие входы C1 или C2.

48 V перем. тока: Подать "N" напряжения питания на управляющие входы C1 или C2.

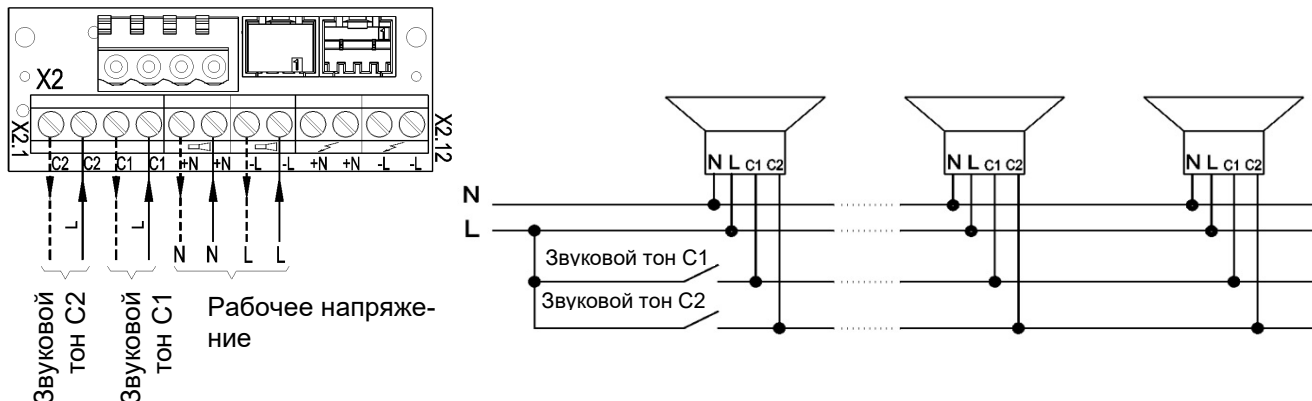

7.1.2 Выбор уровня звукового тона по управляющему входу (TAV), все версии постоянного тока

Указание: Применять только с версией постоянного тока!

На излучатель звука рабочее напряжение может подаваться через управляющие входы C1 или C2 на панели подключения. Таким образом, выбор питания и уровня звукового тона происходит одновременно.

Выполнить перемещение переключателя в следующее положение:

- **S1A** на ∇ (диод не перемкнут)
- Переключатель **S1B** на „+“

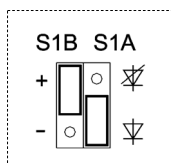

(на плате драйвера)

- Подсоединить отрицательный полюс на панели подключения.
- Подсоединить положительный полюс на панели подключения. Генерируется базовый тон (♩).
- Подсоединение положительного напряжения к C1 на панели подключения генерирует звуковой тон C1.
- Подсоединение положительного напряжения к C2 на панели подключения генерирует звуковой тон C2.
- Одновременное подсоединение положительного напряжения к C1 и C2 на панели подключения генерирует звуковой тон „C1+C2“.

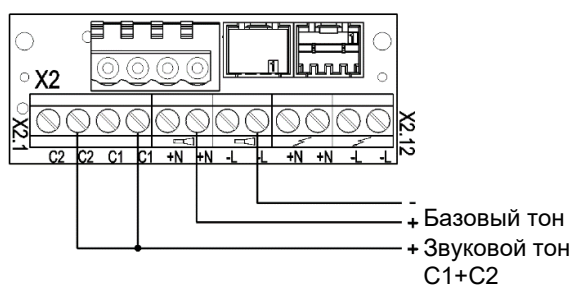
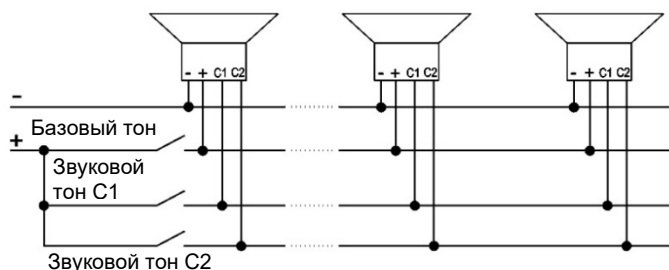
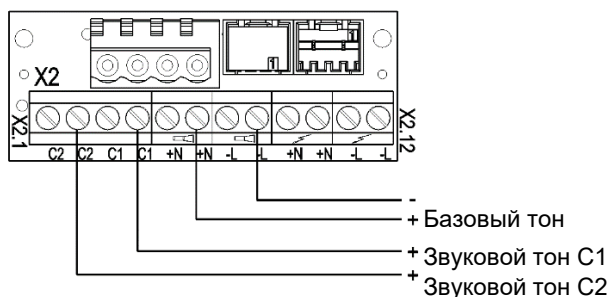

7.1.3 Выбор уровня звукового тона путем инверсии полярности (TAR), все версии постоянного тока (кроме опции –SSM)

Указание: Применять только с версией постоянного тока!

Не применять с версиями –SSM!

Управляющие входы C1 и C2 на панели подключения не разрешается нагружать!

Выполнить перемещение переключателя в следующее положение:

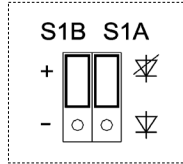

(на плате драйвера)

- **S1A** на ∇ (диод переключен)
- и переключатель **S1B** на „+“

Путем инверсии полярности рабочего напряжения к базовому тону (J) можно выбрать дополнительно звуковой тон „C1+C2“:

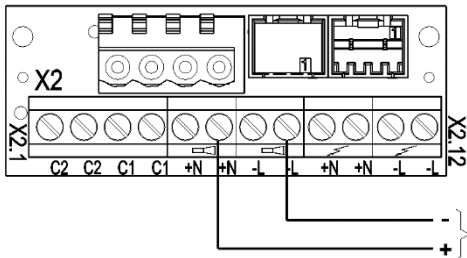

Базовый тон

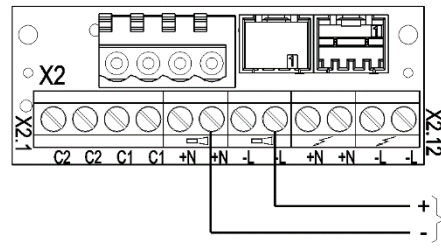

Звуковой тон C1+C2

8. Опция

SSM (Soft-Start-Modul - модуль плавного пуска, только 24 В пост. тока)

Пик тока при включении ограничивается:



Рабочее напряжение подается на оборудование только, начиная с > 7 В.
 Диапазон рабочего напряжения: 18 В – 30 В пост. тока

Положение сопротивления (1 кОм) выполнить следующим образом:

- Всегда устанавливайте сопротивление контроля исправности линии в последнем устройстве.
- При раздельного подключения излучателя звука и лампы-вспышки положение второго сопротивления см. ниже.
- Удалить ненужные сопротивления.

Совместное подключение излучателя звука и лампы-вспышки:

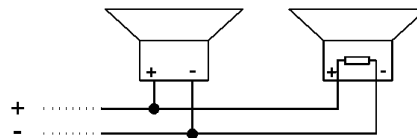
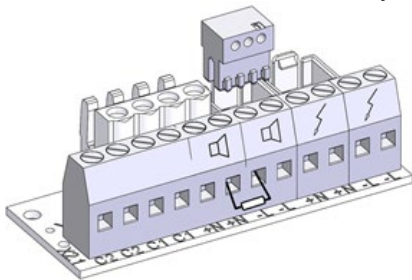

Раздельное подключение излучателя звука и лампы-вспышки:

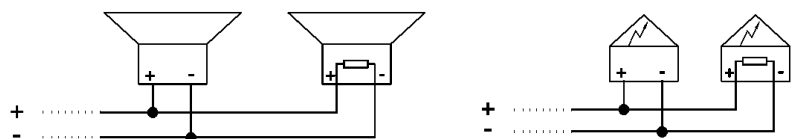
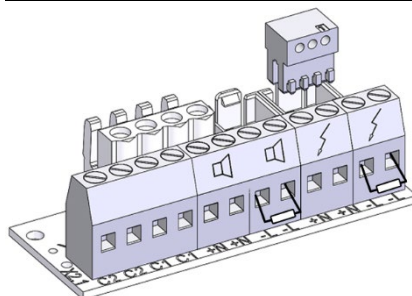

9. Дополнительное оборудование

Номер артикула	Обозначение
28300000002	Заглушка для пломбирования, упаковка 4 шт.
28912000000	Запасной фиксатор, упаковка 4 шт.
28300000004	Контактное уплотнение
28300000007	Монтажный комплект для распределительного щитка РА 1

10. Уход, сервис, техническое обслуживание

- При выполнении любых работ на устройстве соблюдать указания [Указания по технике безопасности](#).

Устройство не требует специального обслуживания.

- Выполнять наружную очистку слабым мыльным раствором без использования растворителей.
- Замена компонентов только на оригинальные запасные части.
- В принципе, ремонт поручать проводить только на заводе-изготовителе.

Модификации, изменения, неправильное и недопустимое использование, а также несоблюдение указаний, приведенных в данном руководстве по эксплуатации, исключают гарантию.

11. Вывод из эксплуатации, демонтаж и утилизация



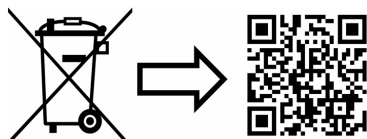





















- При выполнении любых работ на устройстве соблюдать указания [Указания по технике безопасности](#).











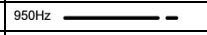
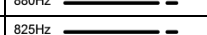
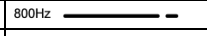
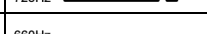
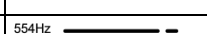

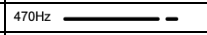
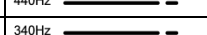

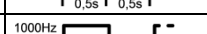

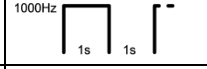

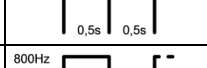
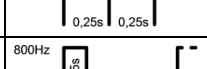
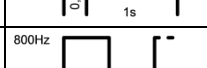

www.pfannenberg.com/disposal

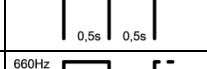
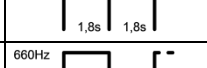
Anhang/ Appendix/ Annexe/ Appendice/ Приложение

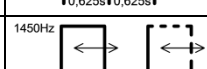
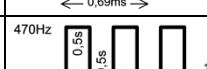
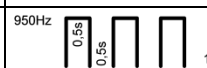
Tonartentabelle/ Tone table/ Tableau de sons/ Tabella suoni/ „Таблица звуковых тонов“

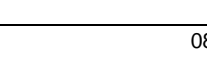
Grund-Ton-Nr. (♫)	Beschreibung/ Description/ Descrizione/ Описание		
1	Kein Ton/ Silence/ Pas de son/ Nessun suono		
2*	Saw tooth, Germany DIN 33404-3 (emergency signal), PFEER PTAP	1200Hz 500Hz	 EN54-3
9	Slow whoop, fire alarm, UK BS5839-1	970Hz 800Hz	
11	Whoop (fast)	970Hz 800Hz	
13	Whoop	900Hz 700Hz	
15	Slow whoop, evacuation, Netherlands NEN 2575	1200Hz 500Hz	 EN54-3
16	Slow whoop, evacuation Australia AS2220	1200Hz 500Hz	
18	Slow whoop, NFPA	775Hz 422Hz	
22	Whoop, Australia AS1670, ISO8201	1200Hz 500Hz	
23	Siren	2400Hz 500Hz	
24	Siren	1200Hz 300Hz	
25	Siren	800Hz 300Hz	
26	Industrial alarm (Germany)	1000Hz 150Hz	
27	Sweeping	2900Hz 2400Hz	
29	Sweeping (fast)	2900Hz 2400Hz	
30	Sweeping	2900Hz 2400Hz	
31	Sweeping, France NF C 48-265	1600Hz 1400Hz	
33	Sweeping, UK BS5839-1 (medium sweep)	1000Hz 800Hz	
34	Sweeping (fast)	1000Hz 800Hz	
35	Sweeping, UK BS5839-1 (fast sweep)	1000Hz 800Hz	
36	Sweeping	1500Hz 700Hz	
43	Sweeping	1200Hz 500Hz	
44	Sweeping, IMO 3d, Germany KTA3901 evacuation	1200Hz 500Hz	
45	Sweeping	1200Hz 500Hz	
46	Sweeping, Finland General Alarm	1500Hz 500Hz	
52	Continuous	2400Hz	
53	Continuous	2000Hz	
54	Continuous, Finland All Clear	1500Hz	
55	Continuous	1200Hz	

(♫)	Beschreibung/ Description/ Descrizione/ Описание	
56	Continuous, PFEER (Gasalarm)	1000Hz 
57	Continuous, UK BS5839-1	950Hz 
59	Continuous	880Hz 
60	Continuous	825Hz  EN54-3
61	Continuous	800Hz 
63	Continuous	725Hz 
65	Continuous, Sweden SS031711 (All Clear)	660Hz 
66	Continuous	554Hz 
67	Continuous, Germany KTA3901 (All Clear)	500Hz 
68	Continuous	470Hz 
69	Continuous	440Hz 
71	Continuous	340Hz 
77	Intermittent	2400Hz 
82	Intermittent, PFEER (General Alarm), UK BS5839-1 (Back-up Alarm)	1000Hz 
83	Intermittent, PFEER (General Alarm)	1000Hz 
88	Intermittent	950Hz 
90	Intermittent	825Hz 
91	Intermittent	800Hz 
92	Intermittent	800Hz 
93	Intermittent (fast), electromechanical horn	800Hz 
97	Intermittent	725Hz 
98	Intermittent, Sweden SS 031711 (Imminent Danger)	700Hz 
100	Intermittent, Industrial Alarm (Germany)	680Hz 
101	Intermittent, Sweden SS031711 (Important Message (Pre Mess))	660Hz 
102	Intermittent, Sweden SS031711 (Local Warning)	660Hz 
103	Intermittent, Sweden SS031711 (Air Raid)	660Hz 
104	Intermittent, Sweden SS031711 (Imminent Danger)	660Hz  EN54-3
107	Intermittent, Germany KTA3901 (evacuation)	500Hz 
109	Intermittent, Australia AS2220, AS1610, AS1670	420Hz 
110	Intermittent (fast variable), Bell	1450Hz 
111	Intermittent, ISO8201 (emergency evacuation signal), USA (evacuation)	470Hz 
112	Intermittent, ISO8201 (emergency evacuation signal)	950Hz
113	Intermittent, ISO8201 (emergency evacuation signal) treble tone	2850Hz

Anhang/ Appendix/ Annexe/ Appendice/ Приложение

Grund-Ton-Nr. (J)	Beschreibung/ Description/ Descrizione/ Описание	
115	Intermittent, IMO (Telefon Call)	950Hz
116	Intermittent, IMO (abandon ship)	950Hz
117	Intermittent, IMO SOLAS III/50 + SOLAS III/6.4 (General Alarm)	825Hz
122	Alternating	2900Hz 2400Hz
123	Alternating	2900Hz 2400Hz
124	Alternating, Singapore	2000Hz 1000Hz
125	Alternating	1400Hz 1200Hz
128	Alternating	1025Hz 825Hz
130	Alternating, UK BS5839-1 (Fire Alarm)	1000Hz 800Hz
131	Alternating, UK BS5839-1 (Fire Alarm, Level crossing)	1000Hz 800Hz
135	Alternating, UK BS5839-1 (Fire Alarm, increased urgency - Level crossing)	1000Hz 800Hz
142	Alternating	900Hz 500Hz
143	Alternating, Germany Industrial Alarm	660Hz 440Hz
144	Alternating	650Hz 440Hz
146	Alternating, France NFS 32-001 (fire alarm)	554Hz 440Hz
147	Alternating, Sweden SS031711 (turn out)	554Hz 440Hz
148	Alternating, Sweden SS031711 (turn out)	554Hz 440Hz
152	Alternating-intermittent	800Hz 650Hz

Tonartenschalter/ Selector -switch (Einstellung des Grundtones/ Adjusting the base tone)							External Tone Control		
1	2	3	4	5	6	Grund-Ton No. (J)	Tone No. C1	Tone No. C2	Tone No. C1+C2
ON		ON	ON			27	123	52	92
	ON	ON	ON			29	35	52	61
ON	ON	ON	ON			30	27	52	77
				ON		31	131	52	57
ON				ON		33	30	52	35
	ON			ON		34	35	52	93
ON	ON			ON		35	27	52	110
		ON		ON		36	146	67	57
ON		ON		ON		43	131	52	91
	ON	ON		ON		45	2	57	93
ON	ON	ON		ON		52	15	65	82
			ON	ON		54	46	54	131
ON			ON	ON		55	131	52	128
	ON		ON	ON		56	82	35	33
ON	ON		ON	ON		59	143	59	101
		ON	ON	ON		60	131	52	125
ON		ON	ON	ON		65	131	52	93
	ON	ON	ON	ON		66	110	52	107
ON	ON	ON	ON	ON		69	131	52	110
					ON	71	131	52	93
ON					ON	77	61	52	122
	ON				ON	82	131	52	83
ON	ON				ON	83	56	2	82
		ON			ON	88	2	57	128
ON		ON			ON	90	131	52	125
	ON	ON			ON	91	30	52	110
ON	ON	ON			ON	92	33	52	57
			ON		ON	93	2	128	57
ON			ON		ON	97	2	63	93
	ON		ON		ON	100	131	52	125
ON	ON		ON		ON	101	98	102	65
		ON	ON		ON	103	131	65	147
ON		ON	ON		ON	104	103	65	101
	ON	ON	ON		ON	109	16	52	22
ON	ON	ON	ON		ON	110	131	61	91
				ON	ON	112	2	57	128
ON				ON	ON	113	52	123	104
	ON			ON	ON	115	117	116	44
ON	ON			ON	ON	116	117	93	125
		ON		ON	ON	117	93	116	125
ON		ON		ON	ON	123	27	52	77
	ON	ON		ON	ON	124	53	83	2
ON	ON	ON		ON	ON	130	2	107	67
			ON	ON	ON	131	2	112	57
ON			ON	ON	ON	135	16	56	109
	ON		ON	ON	ON	142	2	54	88
ON	ON		ON	ON	ON	143	59	93	33
		ON	ON	ON	ON	144	110	61	2
ON		ON	ON	ON	ON	146	31	67	57
	ON	ON	ON	ON	ON	148	131	52	92
ON	ON	ON	ON	ON	ON	152	110	61	13

Ansteuerung der Töne/ Selection of the tones/ Activation des sons/ Controllo dei toni / Управление звуко-выми тонами

Tonartenschalter/ Selector -switch (Einstellung des Grundtones/ Adjusting the base tone)							External Tone Control		
1	2	3	4	5	6	Grund-Ton No. (J)	Tone No. C1	Tone No. C2	Tone No. C1+C2
						1	2	88	57
ON						2 *	128	112	57
	ON					2	26	100	93
ON	ON					2	61	131	112
		ON				9	57	11	82
ON		ON				15	131	52	112
	ON	ON				16	109	52	56
ON	ON	ON				18	111	57	68
			ON			22	16	109	68
ON			ON			23	131	52	112
	ON		ON			24	131	52	131
ON	ON		ON			25	131	52	92
		ON	ON			26	2	100	93

* Werkseinstellung/ Factory setting/ Réglage d'usine/ Impostazione di fabbrica/ Заводская настройка



ELECTRO-TECHNOLOGY FOR INDUSTRY

Pfannenberg GmbH

Werner-Witt-Straße 1 • D- 21035 Hamburg

Tel.: +49/ (0)40/ 734 12-0 • Fax: +49/ (0)40/ 734 12-101

service@pfannenberg.com

http://www.pfannenberg.com