

## Features

- „Easy to Clean“ design based on standard ISO 14 159 und DIN EN 1672-2
- Applications:
  - Machines for food industry
  - Bottling plants
  - Packaging machines
- Application areas:
  - Interface inside the splash zone
  - Connections with chemical resistance and high cleaning cycles
- Materials and resistance:
  - Housing material with FDA 21 approval
  - Ecolab® tested:
    - P3-topax 52
    - P3-topax 19
    - P3-topax 66
    - P3-topax 99
    - P3-topax 56
    - P3-topax 200
  - Acigel, Supergel, Tego 2000

## Technical characteristics

### Hood

Material hood	PP
Material seal outside	EPDM/TPE
Limiting temperatures	-40 °C ... +125 °C
Degree of protection acc. to DIN EN 60 529 locked (80 bar, 80 °C)	IP67 / IP69
Acc. to ISO 20 653 (80 bar, 80 °C)	IP6K9K
Locking	screw locking

### Inserts

Number of contacts	4/4 + PE
Electrical data acc. to EN 61 984	
<b>Power range</b>	<b>16 A 400 V 6 kV 3</b>
Rated current	16 A
Rated voltage	400 V
Rated impulse voltage	6 kV
Pollution degree	3
<b>Control range</b>	<b>10 A 250 V 4 kV 3</b>
Rated current	10 A
Rated voltage	250 V
Rated impulse voltage	4 kV
Pollution degree	3
Insulation resistance	≥ 10 <sup>10</sup> Ω
Material	PC
Limiting temperatures	-40 °C ... +125 °C
Flammability acc. to UL 94	V 0
Mechanical working life	
- mating cycles	≥ 500
- with adapter 09 15 503 9911	≥ 250

### Strain relief

A suitable strain relief is required to enable the F+B connector to resist the stress caused e.g. by the daily cleaning of the machinery. DIN VDE 0100-520: 2013-06 defines the stress relief for a connector depending on the outer diameter of the cable.

Outer Ø of cable	Max. distance of fastening	
	horizontally	vertically
Ø ≤ 9	250	400
9 < Ø ≤ 15	300	400
15 < Ø ≤ 20	350	450
20 < Ø ≤ 40	400	550

### Cleaning distance

For cleaning with high pressure lances, a cleaning distance > 30 cm is recommended in order to avoid mechanical damage to the connector's exterior parts.



Connector for food industry

Identification                      Part number                      Drawing                      Dimensions in mm

Panel mounted housing straight

with through holes for fixing screws



09 15 503 0301

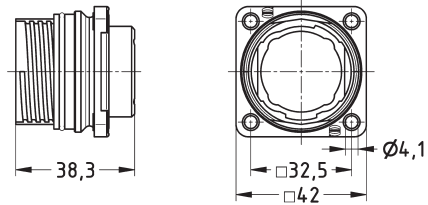

Panel mounted housing angled

with through holes for fixing screws



09 15 503 0901

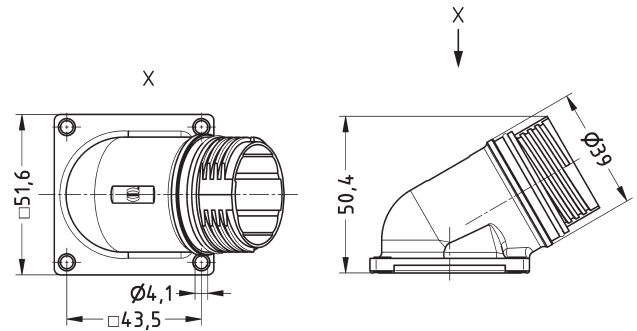

Cover

panel mounted housing



09 15 503 5401

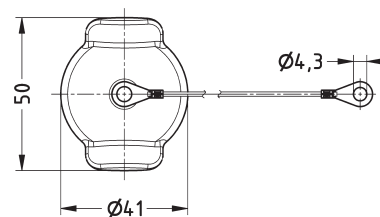





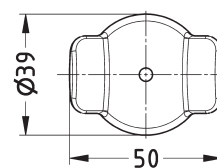

Cover

hood

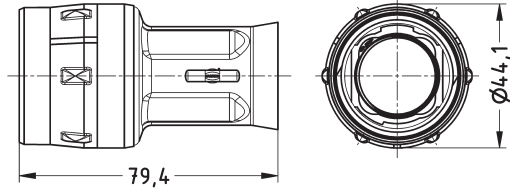

09 15 503 5411

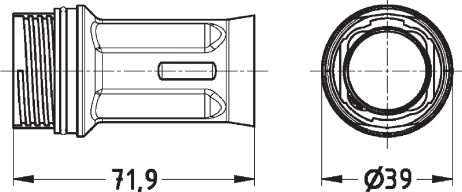

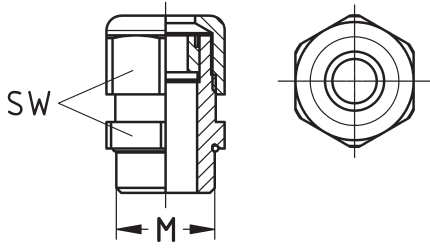
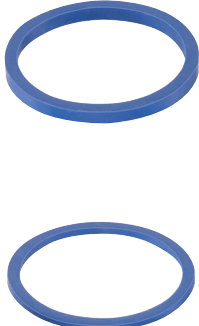
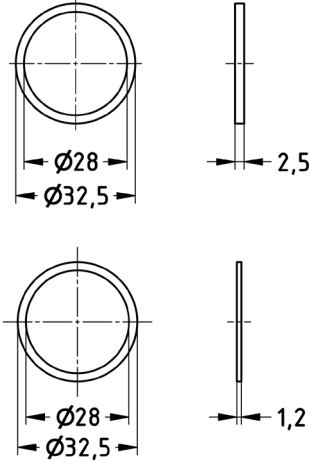
Identification	Part number	Cable entry metric	Drawing	Dimensions in mm
<p>Hood</p> 	<p>19 15 503 1401</p>	<p>M25</p>		
<p>Hoods cable to cable</p> 	<p>19 15 503 1701</p>	<p>M25</p>		
<p>Cable gland</p> <p>black 9 - 16 mm black 13 - 18 mm</p> 	<p>19 00 000 5191 19 00 000 5193</p>	<p>M25 M25</p>		
<p>Lock cover</p> 	<p>09 15 500 9911 09 15 500 9912</p>			

Number of contacts

4 / 4 +

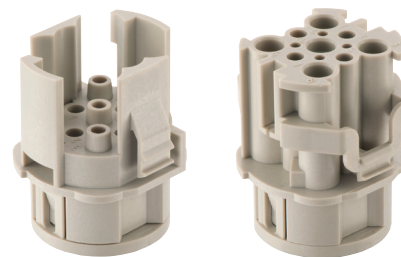

Identification	Part number		Drawing	Dimensions in mm
	Male insert (M)	Female insert (F)		

**Insulator**

4 contacts 16 A + PE  
4 contacts 10 A



09 15 508 3001

09 15 508 3101

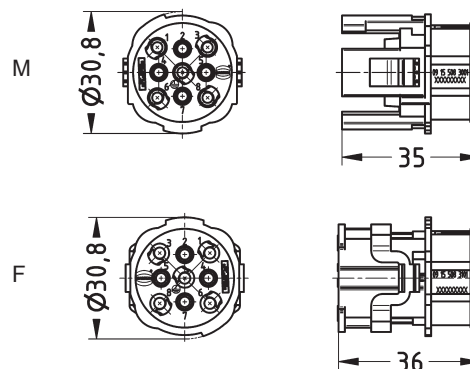

Identification	Part number	Drawing	Dimensions in mm
----------------	-------------	---------	------------------

**Coding pin**

delivery content 20 pieces per bloc



09 12 000 9924

**Contacts**

Han® D and Han® E contacts see catalogue  
"HARTING Industrial Connectors Han®"  
chapters 2 and 3

**Han® 3 A adapter**

for male and female insert  
series on following page





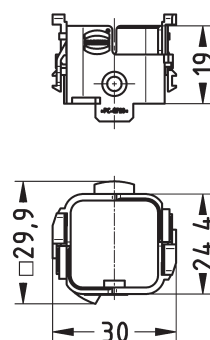



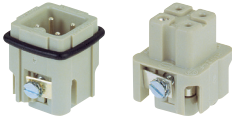

09 15 503 9911

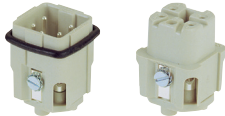

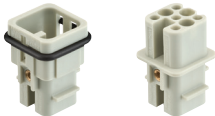
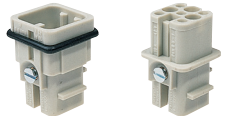
# Summary Han® 3 A for Han® F+B



Series	Han® 3 A	Han® 3 A Quick Lock	Han® 3 A Quick Lock	Han® 4 A
Number of contacts	3 + ⊕	3 + ⊕	3 + ⊕	4 + ⊕
Termination	Screw terminal	Quick Lock terminal	Quick Lock terminal	Screw terminal
				
Rated current	10 A	10 A	10 A	10 A
Rated voltage	230 / 400 V	230 / 400 V	230 / 400 V	230 / 400 V
Wire gauge	1 ... 2.5 mm <sup>2</sup>	0.5 ... 2.5 mm <sup>2</sup>	0.25 ... 1.5 mm <sup>2</sup>	1 ... 2.5 mm <sup>2</sup>
Male insert (M)	09 20 003 2611	09 20 003 2633	09 20 003 2634	09 20 004 2611
Female insert (F)	09 20 003 2711	09 20 003 2733	09 20 003 2734	09 20 004 2711
Series	Han® 4 A Quick Lock	Han® 4 A Quick Lock	Han® 7 D	Han® 8 D
Number of contacts	4 + ⊕	4 + ⊕	7 + ⊕	8
Termination	Quick Lock terminal	Quick Lock terminal	Crimp terminal	Crimp terminal
				
Rated current	10 A	10 A	10 A	10 A
Rated voltage	230 / 400 V	230 / 400 V	250 V	~ 50 V / – 120 V
Wire gauge	0.5 ... 2.5 mm <sup>2</sup>	0.25 ... 1.5 mm <sup>2</sup>	0.14 ... 2.5 mm <sup>2</sup>	0.14 ... 2.5 mm <sup>2</sup>
Male insert (M)	09 20 004 2633	09 20 004 2634	09 21 007 3031	09 36 008 3001
Female insert (F)	09 20 004 2733	09 20 004 2734	09 21 007 3131	09 36 008 3101
Series	Han® Q 5/0	Han® Q 7/0	Han® High Density	Han® Q 2/0
Number of contacts	5 + ⊕	7 + ⊕	21	2 + ⊕
Termination	Crimp terminal	Crimp terminal	Crimp terminal	Axial screw terminal
				
Rated current	16 A	10 A	6.5 A	40 A
Rated voltage	230 / 400 V	400 V	~ 50 V / – 120 V	400 V
Wire gauge	0.14 ... 2.5 mm <sup>2</sup>	0.14 ... 2.5 mm <sup>2</sup>	0.09 ... 0.56 mm <sup>2</sup>	4 ... 10 mm <sup>2</sup>
Male insert (M)	09 12 005 3001	09 12 007 3001	09 12 021 3001	09 12 002 2651
Female insert (F)	09 12 005 3101	09 12 007 3101	09 12 021 3101	09 12 002 2751

# Summary Han® 3 A for Han® F+B



Series	Han® Q 2/0	Han® Q 2/0	Han® Q 5/0 Quick Lock	Han® Q 12/0
Number of contacts	2 + ⊕	2 + ⊕	5 + ⊕	12 + ⊕
Termination	Crimp terminal	Crimp terminal	Quick Lock terminal	Crimp terminal/ Quick Lock terminal
Rated current	40 A	40 A	16 A	10 A
Rated voltage	400 V	830 V	230 / 400 V	400 V
Wire gauge	1.5 ... 10 mm <sup>2</sup>	1.5 ... 10 mm <sup>2</sup>	0.5 ... 2.5 mm <sup>2</sup>	0.14 ... 2.5 mm <sup>2</sup>
Male insert (M)	09 12 002 3051	09 12 002 3052	09 12 005 2633	09 12 012 3001
Female insert (F)	09 12 002 3151	09 12 002 3152	09 12 005 2733	09 12 012 3101

